

TEST REPORT

Applicant Name & Address : Shenzhen SOFARSOLAR Co., Ltd.
3A-1, Huake Building, East Technology Park, Qiaoxiang Road, Nanshan District, Shenzhen, China

Manufacturing Site : Suga Networks Equipment (Shenzhen) Co., Ltd.
Floor 1 East & Floor 2 of Building B(Manufacturing Site), Floor 3 & 4 of Building A(Office Site), Block 12, Xi Cheng Industrial Park, Xi Xiang Street, BaoAn District, Shenzhen City, China

Sample Description

Product : Grid-connected PV inverter

Model No. : Sofar 20000TL-Sx, Sofar 17000TL-Sx, Sofar 15000TL-Sx, Sofar 10000TL-Sx (x=0-6)

Electrical Rating : Maximum d.c. input voltage: 1000 V
Input voltage rang: 250-960 V
Operating temperature range: -25~60°C
(See page 5 for details)

Date Received : 18 September 2013

Date Test Conducted : 23 November 2013-26 November 2013

Test standards : EN 61000-6-2: 2005
EN 61000-6-4: 2007+A1: 2011

Test Result : Pass

Conclusion : The submitted samples complied with the above EMC standards.

Remark : None.

*****End of Page*****

Prepared and Checked By:

Approved By:



Ivan Zhou
Project Engineer
Intertek Guangzhou

Helen Ma *Signature*

Helen Ma
Sr. Project Engineer
Intertek Guangzhou

24 January 2014 *Date*

This report is for the exclusive use of Intertek's Client and is provided pursuant to the agreement between Intertek and its Client. Intertek's responsibility and liability are limited to the terms and conditions of the agreement. Intertek assumes no liability to any party, other than to the Client in accordance with the agreement, for any loss, expense or damage occasioned by the use of this report. Only the Client is authorized to permit copying or distribution of this report and then only in its entirety. Any use of the Intertek name or one of its marks for the sale or advertisement of the tested material, product or service must first be approved in writing by Intertek. The observations and test results in this report are relevant only to the sample tested. This report by itself does not imply that the material, product, or service is or has ever been under an Intertek certification program. The test report only allows to be revised within three years from its original issued date unless further standard or the requirement was noticed.

CONTENT

TEST REPORT	1
CONTENT	2
1 TEST RESULTS SUMMARY	4
2 EMC RESULTS CONCLUSION	5
3 LABORATORY MEASUREMENTS	7
4 EMI TEST	8
4.1 EN 61000-6-4 EMISSION-LOW VOLTAGE AC MAINS (CONTINUOUS CONDUCTED DISTURBANCE VOLTAGE).....	8
4.1.1 Used Test Equipment	8
4.1.2 Block Diagram of Test Setup	8
4.1.3 Test Setup and Procedure	8
4.1.4 Emission Curve & Test Data	9
4.1.5 Measurement Uncertainty	11
4.2 EN 61000-6-4 EMISSION-TELECOMMUNICATION/ NETWORK PORTS	11
4.3 EN 61000-6-4 EMISSION- LOW VOLTAGE AC MAINS (DISCONTINUOUS CONDUCTED DISTURBANCE VOLTAGE).....	11
4.3.1 Used Test Equipment	11
4.3.2 Block Diagram of Test Setup	11
4.3.3 Test Setup and Procedure	11
4.3.4 Test Data	12
4.3.5 Measurement Uncertainty	12
4.4 EN 61000-6-4 EMISSION-ENCLOSURE PORT	13
4.4.1 Used Test Equipment	13
4.4.2 Block Diagram of Test Setup	13
4.4.3 Test Setup and Procedure	13
4.4.4 Test Curve & Test Data	14
4.4.5 Measurement uncertainty	15
5 EMS TEST.....	16
5.1 EN 61000-6-2 ELECTROSTATIC DISCHARGE IMMUNITY	16
5.1.1 Used Test Equipment	16
5.1.2 Block Diagram of Test Setup	17
5.1.3 Test Setup and Procedure	17
5.1.4 Test Result	19
5.2 EN 61000-6-2 INJECTED CURRENT (0.15 MHz TO 80 MHz)	20
5.2.1 Used Test Equipment	20
5.2.2 Block Diagram of Test Setup	20
5.2.3 Test Setup and Procedure	20
5.2.4 Test Result	21
5.3 EN 61000-6-2 ELECTRICAL FAST TRANSIENT/BURST	21
5.3.1 Used Test Equipment	21
5.3.2 Block Diagram of Test Setup	21
5.3.3 Test Setup and Procedure	22
5.3.4 Test Result	22
5.4 EN 61000-6-2 SURGE IMMUNITY	23
5.4.1 Used Test Equipment	23
5.4.2 Block Diagram of Test Setup	23
5.4.3 Test Setup and Procedure	23
5.4.4 Test Result	24
5.5 EN 61000-6-2 VOLTAGE DIPS AND INTERRUPTIONS.....	24
5.6 EN 61000-6-2 RADIATED ELECTROMAGNETIC FIELD IMMUNITY	24

5.6.1	<i>Used Test Equipment</i>	24
5.6.2	<i>Block Diagram of Test Setup</i>	25
5.6.3	<i>Test Setup and Procedure</i>	25
5.6.4	<i>Test Result</i>	26
5.7	EN 61000-6-2 POWER FREQUENCY MAGNETIC FIELD IMMUNITY	27
5.7.1	<i>Used Test Equipment</i>	27
5.7.2	<i>Block Diagram of Test Setup</i>	27
5.7.3	<i>Test Setup and Procedure</i>	27
5.7.4	<i>Test Result</i>	28
6	APPENDIX I - PHOTOS OF TEST SETUP	29
7	APPENDIX II- PHOTOS OF EUT	34

1

TEST RESULTS SUMMARY

Test Item	Standard	Result
Emission-Low voltage AC mains (Continuous conducted disturbance voltage)	EN 61000-6-4:2007+A1: 2011 Reference: EN 55022: 2006	Pass
Emission- Telecommunication/ Network Ports	EN 61000-6-4:2007+A1: 2011 Reference: EN 55022: 2006	N/A
Emission- Low voltage AC mains (Discontinuous conducted disturbance voltage)	EN 61000-6-4:2007+A1: 2011 Reference: EN 55014-1: 2006+A1:2009	Pass
Emission-Enclosure port	EN 61000-6-4:2007+A1: 2011 Reference: EN 55022: 2006	Pass
ESD immunity	EN 61000-6-2:2005 Reference: EN 61000-4-2: 1995+A1: 1998+A2: 2001	Pass
Inject current immunity	EN 61000-6-2:2005 Reference: EN 61000-4-6: 2007	Pass
Surge immunity	EN 61000-6-2:2005 Reference: EN 61000-4-5: 2006	Pass
EFT immunity	EN 61000-6-2:2005 Reference: EN 61000-4-4: 2004	Pass
Radiated EM field immunity	EN 61000-6-2:2005 Reference: EN 61000-4-3: 2006	Pass
Voltage dips and interruption immunity	EN 61000-6-2:2005 Reference: EN 61000-4-11: 2004	N/A
Power frequency magnetic field immunity	EN 61000-6-2:2005 Reference: EN 61000-4-8: 1993+A1: 2000	Pass

Remark: 1. The symbol “N/A” in above table means Not Applicable.
 2. When determining the test results, measurement uncertainty of tests has been considered.

2 EMC Results Conclusion (with Justification)

RE: EMC Testing Pursuant to EMC Directive 2004/108/EC Performed On the Grid-connected PV inverter, Models: Sofar 20000TL-Sx, Sofar 17000TL-Sx, Sofar 15000TL-Sx, Sofar 10000TL-Sx (x=0-6).

We tested the Grid-connected PV inverter, Model: Sofar 20000TL-S6, to determine if it was in compliance with the relevant EN standards as marked on the Test Results Summary. We found that the units met the requirement of EN 61000-6-4, EN 61000-6-2 standards when tested as received. The worst case's test data was presented in this test report.

Electrical Rating:

Maximum d.c. input voltage: 1000 V

Input voltage rang: 250-960 V

Max. input current: 2×24 A (for Sofar 20000TL-Sx); 2×21 A (for Sofar 17000TL-Sx, Sofar 15000TL-Sx); 2×15 A (for Sofar 10000TL-Sx)

Max. PV Isc: 2×30 A (for Sofar 20000TL-Sx); 2×27 A (for Sofar 17000TL-Sx, Sofar 15000TL-Sx); 2×20 A (for Sofar 10000TL-Sx)

Nominal output voltage: 3/N/PE230V/400V

Max. output current: 3×29 A (for Sofar 20000TL-Sx); 3×25 A (for Sofar 17000TL-Sx); 3×22 A (for Sofar 15000TL-Sx); 3×15 A (for Sofar 10000TL-Sx)

Nominal frequency: 50 Hz

Max. output power: 20000 W (for Sofar 20000TL-Sx); 17000 W (for Sofar 17000TL-Sx); 15000 W (for Sofar 15000TL-Sx); 10000 W (for Sofar 10000TL-Sx)

Ingress protection: IP65

Operating temperature range: -25~60°C

General product information:

Product covered by this report is grid-connected PV inverter for indoor or outdoor installation. The connection to the DC input and AC output are through connectors. The structure of the unit complied with the IP 65 requirement.

The inverters intended to operate at ambient temperature -25°C - +60°C and 250-960 Vdc input, which will be specified in the user manual, The inverters will output full power when operated at 45°C. If operated at higher than 45°C temperature, the output power derating.

For all models, if the DC input voltage is higher than 850 Vdc the output power will be derating.

For model Sofar 20000TL-Sx, if the DC input voltage is lower than 430 Vdc, the output power will be derating.

For model Sofar 17000TL-Sx, if the DC input voltage is lower than 420 Vdc, the output power will be derating.

For model Sofar 15000TL-Sx, if the DC input voltage is lower than 370 Vdc, the output power will be derating.

For model Sofar 10000TL-Sx, if the DC input voltage is lower than 350 Vdc, the output power will be derating.

For all models, if the AC output voltage is lower than 230 Vac the output current will be limited to not higher than rated output current.

All the models have identical mechanical and electrical construction except some components and some parameter of the software architecture in order to control the max output power.

Other than special notice, the model Sofar 20000TL-S6 is as the representative test models in this report

The production units are required to conform to the initial sample as received when the units are placed on the market.

3 LABORATORY MEASUREMENTS

Configuration Information

Equipment Under Test (EUT):	Grid-connected PV inverter
Model:	Sofar 20000TL-S6
Serial No.	Not Labeled
Support Equipment:	AC-DC source provided by client
Rated Voltage:	Input: 720VDC; Output: 400V, 50Hz, 3phases
Condition of Environment:	Temperature : 22~28°C Relative Humidity: 35~60% Atmosphere Pressure 86~106kPa

Notes:

1. The EMI measurements had been made in the operating mode producing the largest emission in the frequency band being investigated consistent with normal applications.

An attempt had be made to maximize the emission by varying the configuration of the EUT.

2. The EMS measurements had been made in the frequency bands being investigated, with the EUT in the most susceptible operating mode consistent with normal applications. The configuration of the test sample had been varied to achieve maximum susceptibility.

4 EMI TEST

4.1 EN 61000-6-4 Emission-Low voltage AC mains (Continuous conducted disturbance voltage)

Test Result: Pass

4.1.1 Used Test Equipment

Equipment No.	Equipment	Model	Manufacturer
828985/018	Test Receiver	ESCS30	Rohde & Schwarz
8129-203	L.I.S.N.	NNLK8129	Schwarzbeck
M20531	50Ω Coaxial Switch	MP59B	Anritsu
100006	Pulse Limiter	ESH3-Z2	Rohde & Schwarz

4.1.2 Block Diagram of Test Setup

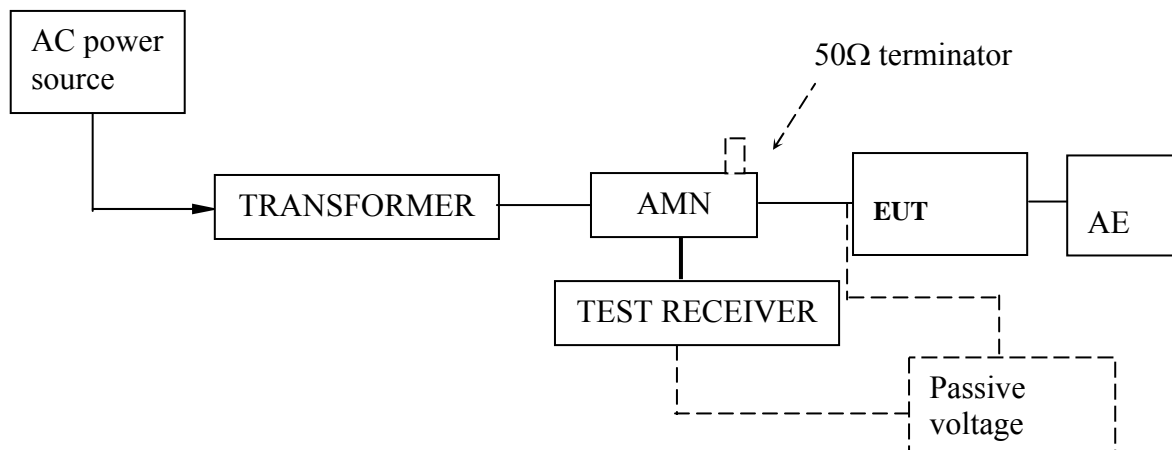

4.1.3 Test Setup and Procedure

The EUT was set to achieve the maximum emission level. The mains terminal disturbance voltage was measured with the EUT in a shielded room. The EUT was connected to AC power source through an Artificial Mains Network which provides a 50Ω linear impedance Artificial hand is used if appropriate (for handheld apparatus). The load/control terminal disturbance voltage was measured with passive voltage probe if appropriate.

The EUT was placed on a 0.8m high non-metallic table above a metallic plane, and 0.4m from wall of shielded room which is considered as Ground Reference Plane (GRP) (For floor standing EUT, was placed on a 0.1m high non-metallic supported on GRP) The EUT keeps a distance of at least 0.8m from any other of the metallic surface. The Artificial Mains Network is situated at a distance of 0.8m from the EUT.

During the test, mains lead of EUT excess 0.8m was folded back and forth parallel to the lead so as to form a horizontal bundle with a length between 0.3m and 0.4m.

The bandwidth of test receiver was set at 9 kHz. The frequency range from 150 kHz to 30MHz was checked.

4.1.4 Emission Curve & Test Data

At low voltage AC main terminal: Pass

Tested Wire: N

Operation Mode: Grid-connected, full load

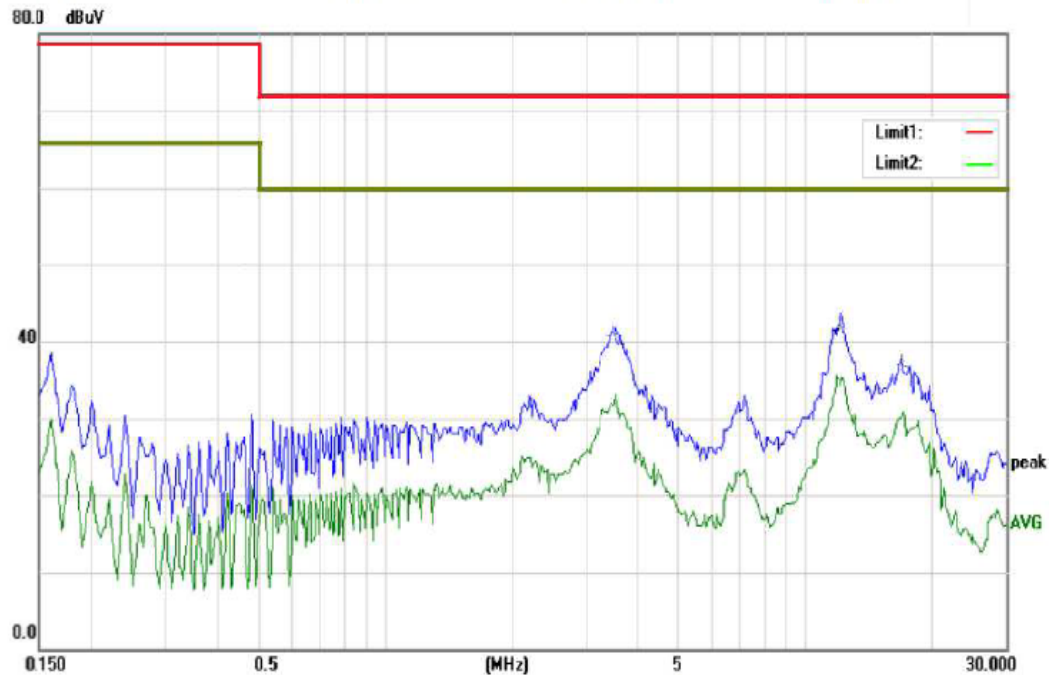

Tested Wire: L1

Operation Mode: Grid-connected, full load

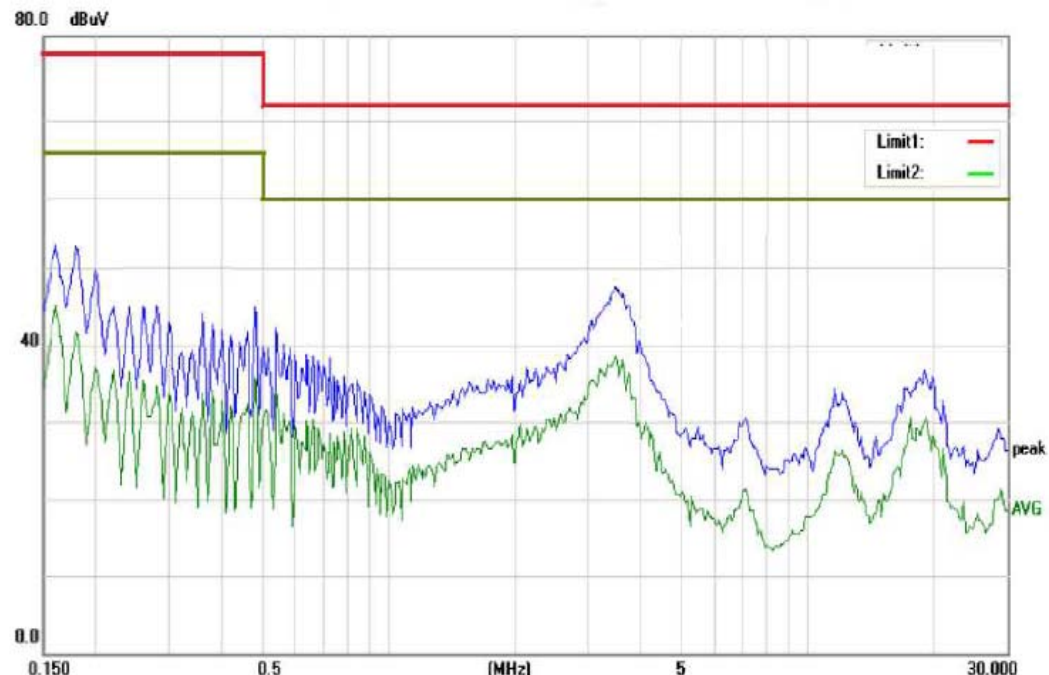

Tested Wire: L2

Operation Mode: Grid-connected, full load

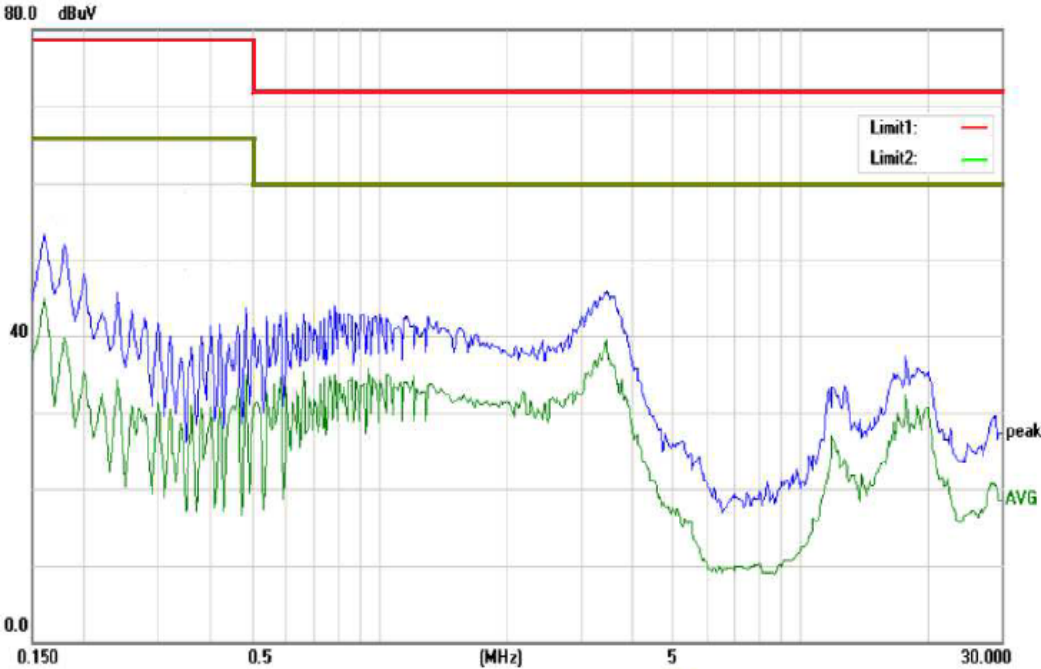

Tested Wire: L3

Operation Mode: Grid-connected,, full load

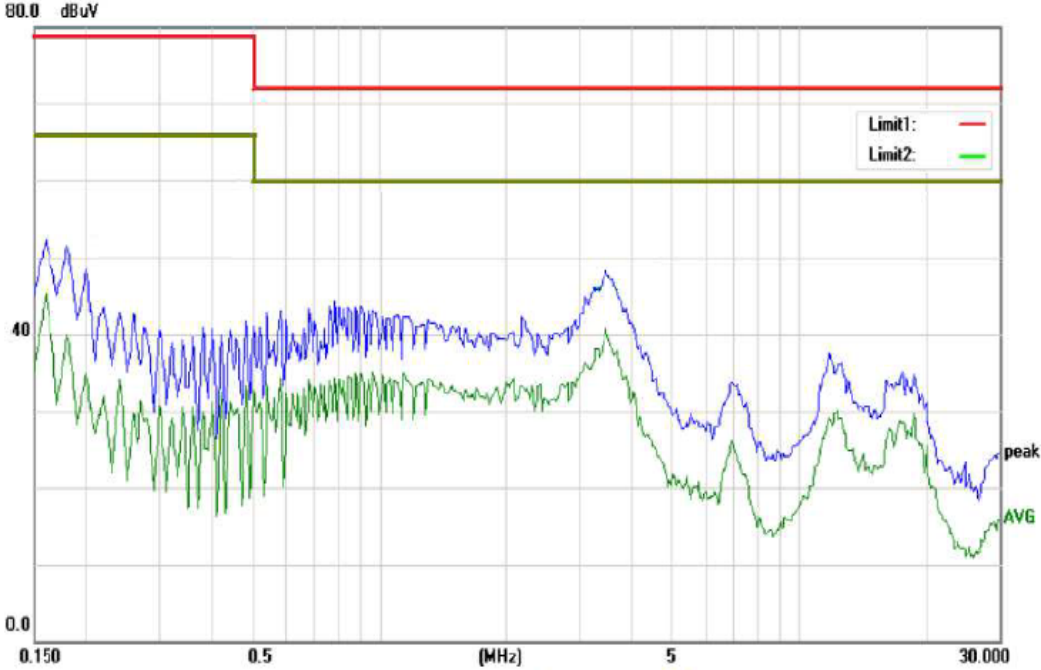

Remark: The margin is greater than 10dB.

4.1.5 Measurement Uncertainty

The measurement uncertainty describes the overall uncertainty of the given measured value during the operation of the EUT.

Measurement uncertainty is calculated in accordance with CISPR 16-4-2:2003.

Measurement uncertainty of mains terminal disturbance voltage in CISPR band B: 2.3dB.

The measurement uncertainty is given with a confidence of 95%, $k=2$.

4.2 EN 61000-6-4 Emission-Telecommunication/ Network Ports

Test Result: Not Applicable

Remark: The test only apply to balanced telecommunication ports intended for connection to screened cables and coaxial cables.

4.3 EN 61000-6-4 Emission- Low voltage AC mains (Discontinuous conducted disturbance voltage)

Test Result: Pass

4.3.1 Used Test Equipment

Equipment No.	Equipment	Model	Manufacturer
828985/018	Test Receiver	ESCS30	Rohde & Schwarz
8129-203	L.I.S.N.	NNLK8129	Schwarzbeck
M20531	50Ω Coaxial Switch	MP59B	Anritsu
100006	Pulse Limiter	ESH3-Z2	Rohde & Schwarz

4.3.2 Block Diagram of Test Setup

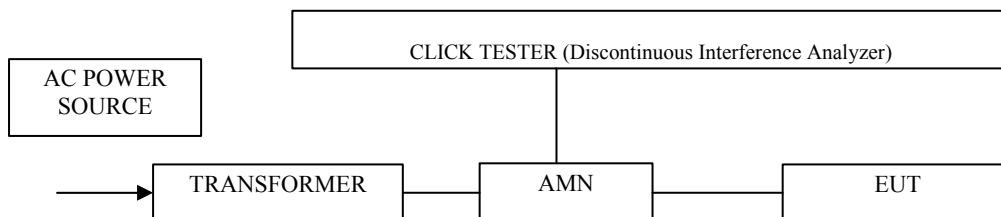

4.3.3 Test Setup and Procedure

The EUT was placed on a 0.1m high non-metallic table and keeps a distance of at least 0.8m from any of the other metallic surface.

The EUT was tested using the Artificial Mains Network as a voltage probe. The excess lead of EUT was bundled with a length of 0.3m to 0.4m parallel to the main lead.

The number of counted clicks above the permitted limit for continuous interference and their duration, spacing and rate were measured during the observation time. When relevant, a permitted(relaxed) limit for clicks were calculated and a second measurement was performed.

Determination of compliance with the permitted limit according to the upper quartile method was applied. The frequency 150kHz, 500 kHz, 1.4 MHz and 30 MHz was checked.

4.3.4 Test Data

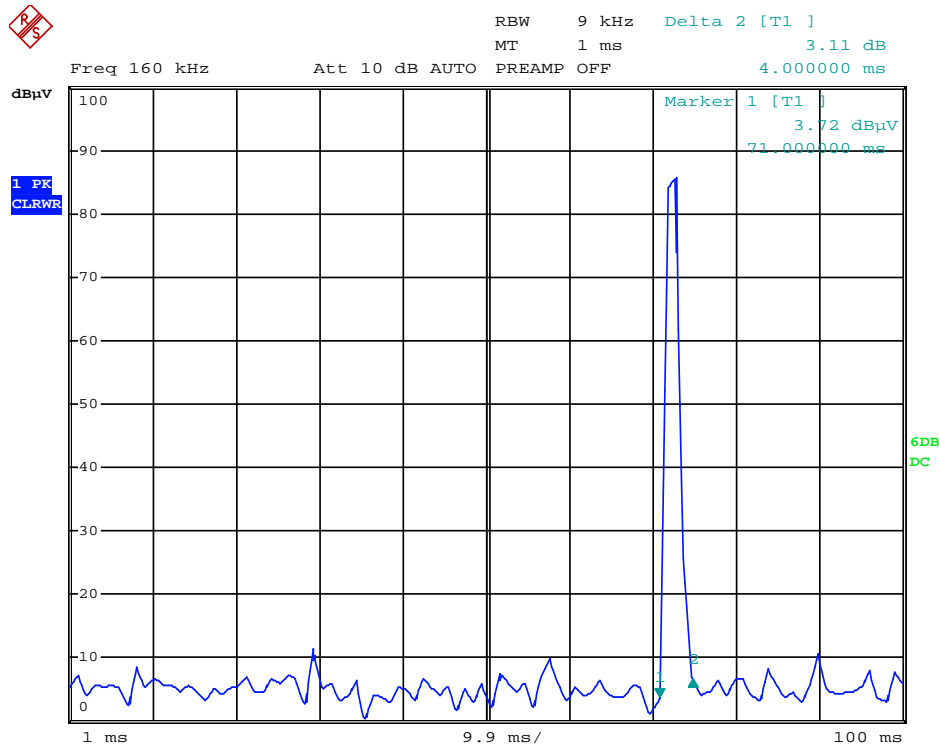

The appliance was deemed to comply with the limits if fulfilling the three conditions below:

- the click rate is not more than 5.
- none of the caused clicks has a duration longer than 20 ms.
- 90 % of the caused clicks have a duration less than 10 ms.

4.3.5 Measurement Uncertainty

The measurement uncertainty for click test is under consideration according to CISPR 16-4-2:2003.

4.4 EN 61000-6-4 Emission-Enclosure port

Test Result: Pass

Remark: The highest internal frequency of the EUT is less than 108 MHz.

4.4.1 Used Test Equipment

Equip. No.	Equipment	Model	Manufacturer
101045	EMI Test Receiver	ESCI	Rohde & Schwarz
22013	Pre-Amplifier	PAP-0203	CD
141	Bilog Antenna	VULB9163	Schwarzbeck

4.4.2 Block Diagram of Test Setup

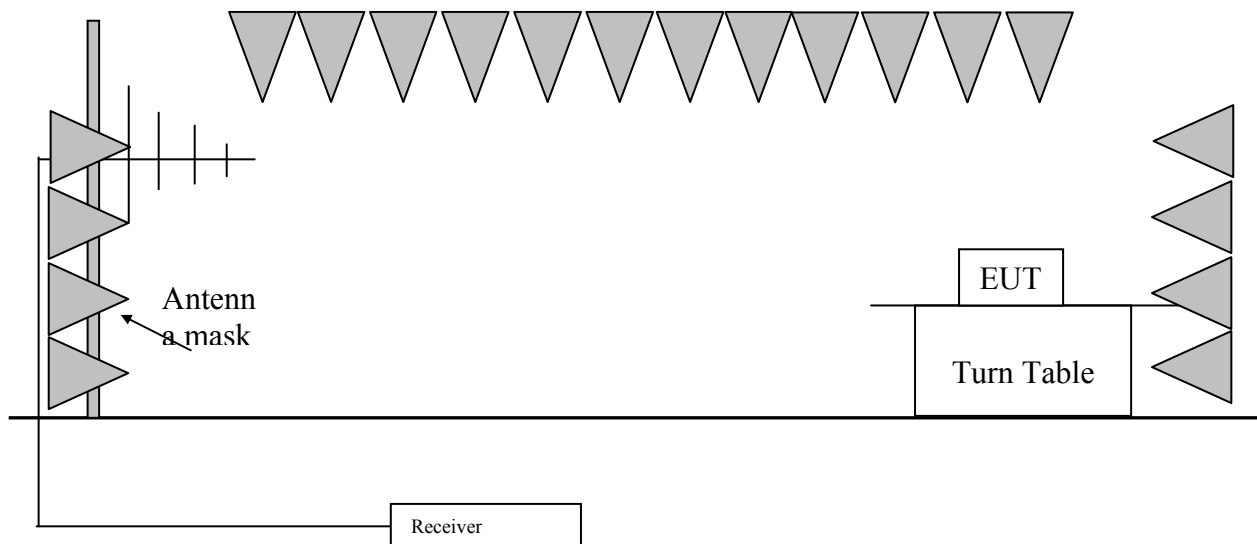

4.4.3 Test Setup and Procedure

The measurement was applied in a semi-anechoic chamber. The EUT and simulators were placed on a 0.8m high wooden turntable above the horizontal metal ground plane. The turn table rotated 360 degrees to determine the position of the maximum emission level. The EUT was set 3 meters away from the receiving antenna which was mounted on an antenna mask. The antenna moved up and down between from 1meter to 4 meters to find out the maximum emission level. Broadband antenna was used as receiving antenna. Both horizontal and vertical polarization of the antenna was set on measurement. In order to find the maximum emission, all of the interface cables were manipulated according to EN55022 requirement during radiated test.

The bandwidth setting on R&S Test Receiver was 120 kHz.

The frequency range from 30MHz to 1000MHz was checked

4.4.4 Test Curve & Test Data

Operation Mode: Grid-connected, full load
Horizontal

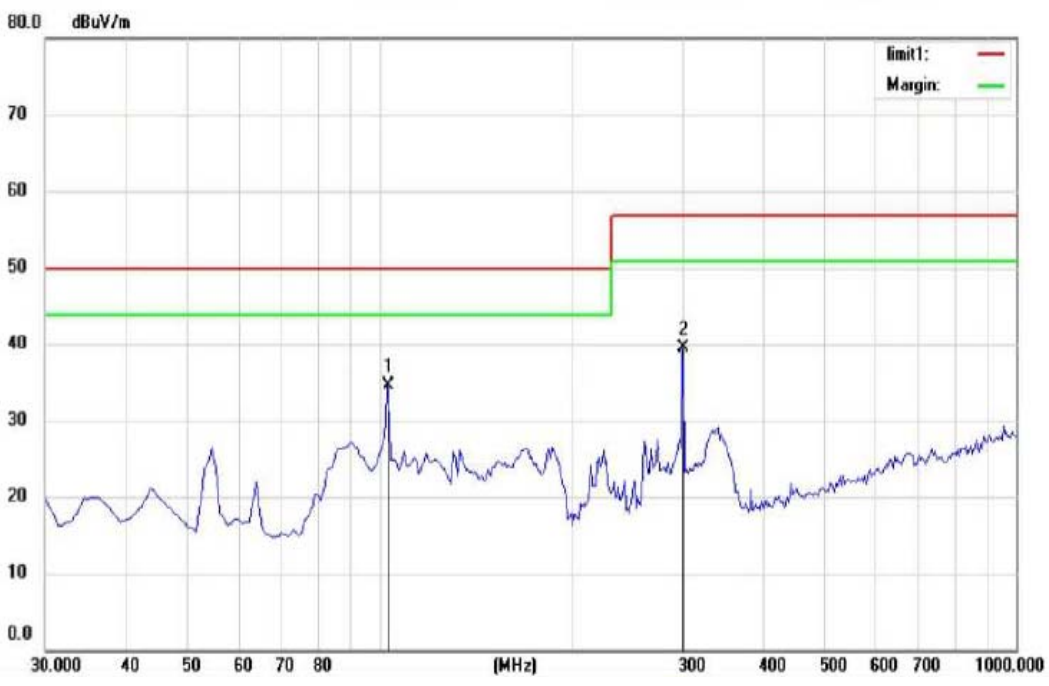

Vertical

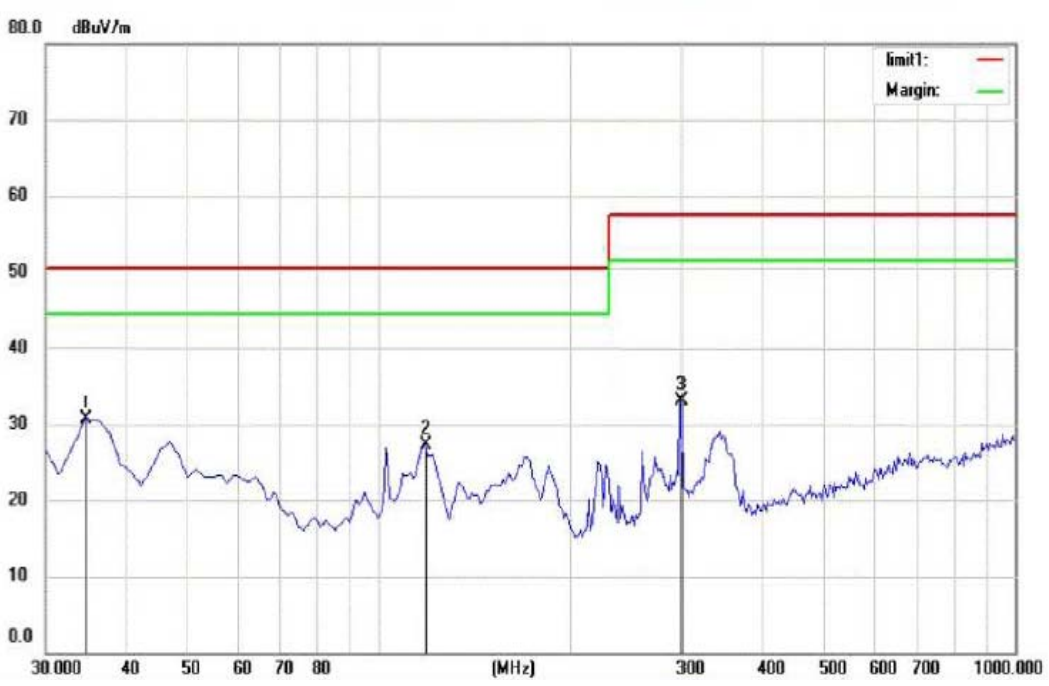

4.4.5 Measurement uncertainty

The measurement uncertainty describes the overall uncertainty of the given measured value during the operation of the EUT.

Measurement uncertainty is calculated in accordance with CISPR 16-4-2:2003.

Measurement uncertainty of radiated emission: 4.8 dB.

The measurement uncertainty is given with a confidence of 95%, $k=2$.

5 EMS TEST

Performance Criteria:

Criterion A: The apparatus shall continue to operate as intended during the test. No degradation of performance or loss of function is allowed below a performance level (or permission loss of performance) specified by the manufacturer, when the apparatus is used as intended. If the minimum performance level or the permissible performance loss is not specified by the manufacturer, then either of these may be derived from the product description and documentation and from what the user may reasonably expect from the apparatus if used as intended.

Criterion B: The apparatus shall continue to operate as intended after the test. No degradation of performance or loss of function is allowed below a performance level (or permission loss of performance) specified by the manufacturer, when the apparatus is used as intended. During the test, degradation of performance is allowed, however, no change of actual operating state or stored data is allowed. If the minimum performance level or the permissible performance loss is not specified by the manufacturer, then either of these may be derived from the product description, and documentation, and from what the user may reasonably expect from the apparatus if used as intended.

Criterion C: Temporary loss of function is allowed, provided the function is self-recoverable or can be restored by the operation of the controls, or by any operation specified in the instruction for use.

Measurement Uncertainty

According to CISPR 16-4-2:2003, measurement uncertainty to immunity test is under consideration.

5.1 EN 61000-6-2 Electrostatic Discharge Immunity

Tested Port: Enclosure

Performance criterion: B

Test Result: Pass

5.1.1 Used Test Equipment

Equip. No.	Equipment	Model	Manufacturer
130	ESD Tester	NSG 438A	TESEQ AG
403-550/1712	Impulse Module	INA 4380-150pF/330Ohm	TESEQ AG

5.1.2 Block Diagram of Test Setup

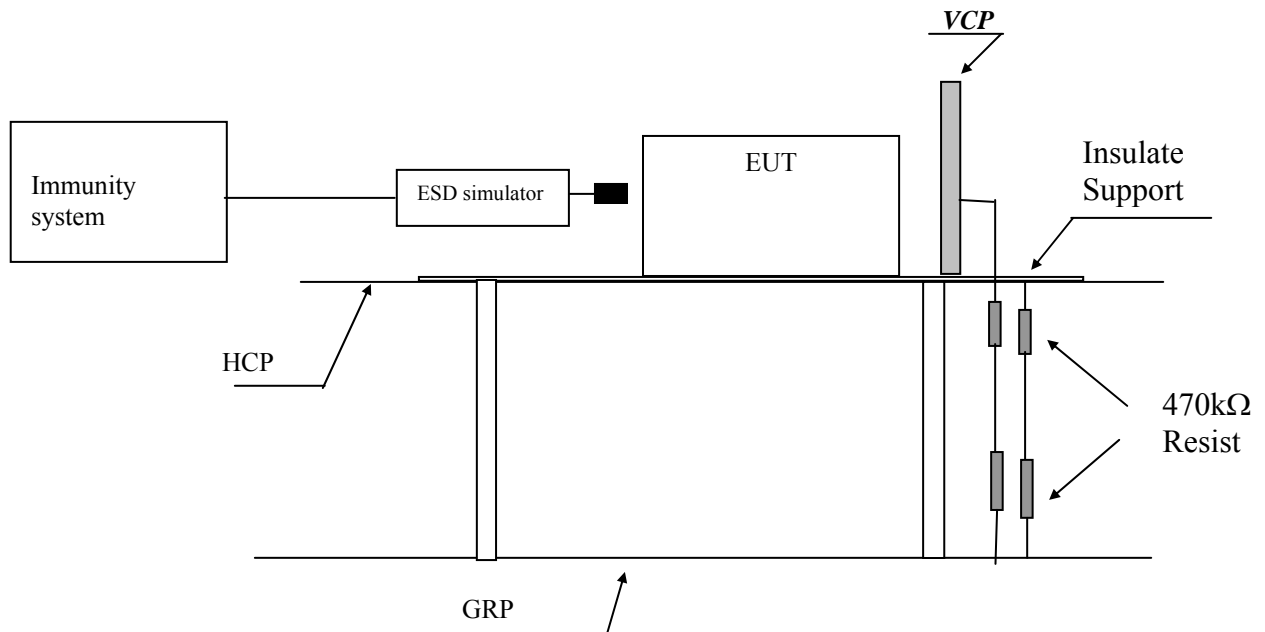

Note: HCP means Horizontal Coupling Plane,
 VCP means Vertical Coupling Plane
 GRP means Ground Reference Plane

5.1.3 Test Setup and Procedure

The EUT was put on a 0.8m high wooden table/0.1m high for floor standing equipment standing on the ground reference plane (GRP) 3m by 2m in size, made by iron 1.0 mm thick.

A horizontal coupling plane (HCP) 1.6m by 0.8m in size was placed on the table, and the EUT with its cables were isolated from the HCP by an insulating support thick than 0.5mm. The VCP 0.5m by 0.5m in size & HCP were constructed from the same material type & thickness as that of the GRP, and connected to the GRP via a 470kΩ resistor at each end.

The distance between EUT and any of the other metallic surface excepted the GRP, HCP & VCP was greater than 1m.

The EUT was arranged and connected according to its functional requirements.
 The EUT was arranged and connected according to its functional requirements

Direct static electricity discharges was applied only to those points and surface which are accessible to personnel during normal usage.

Test voltage was increased from the minimum to the selected test level and with single discharge.

On each preselected points 10 times of each polarity single discharge were applied The time interval between successive single discharges is 1s.

The ESD generator was held perpendicular to the surface to which the discharge is applied. The discharge return cable of the generator was kept at a distance of 0.2m whilst the discharge is being applied. During the contact discharges, the tip of the discharge electrode was touch the EUT before the discharge switch is operated. During the air discharges, the round discharge tip of the discharge electrode was approached as fast as possible to touch the EUT.

Indirect discharge was conducted to objects placed near the EUT, simulated by applying the discharges of the ESD generator to a coupling plane, in the contact discharge mode.

After each discharge, the ESD generator was removed from the EUT, the generator is then retriggered for a new single discharge. For ungrounded product, a grounded carbon fibre brush with bleeder resistors ($2 \times 470 \text{ k}\Omega$) in the grounding cable was used after each discharge to remove remnant electrostatic voltage.

10 times of each polarity single discharge were applied to HCP and VCP. The detail selected points are listed in the following table.

5.1.4 Test Result

Direct Application of ESD

Direct Contact Discharge

Applied Voltage (kV)	No. of Discharge for each point	Discharged Points	Result
4	20	Accessible metal parts of the EUT Conductive substrate with coating which is not declared to be insulating	Pass

Direct Air Discharge

Applied Voltage (kV)	No. of Discharge for each point	Discharged Points	Result
8	20	All accessible points where contact discharge cannot be applied such as Displays, Indicators light, Keyboard, Button, Switch, Knob, Air gap, Slots, Hole and so on	Pass

Indirect Application of ESD

Horizontal Coupling Plane under the EUT

Applied Voltage (kV)	No. of Discharge for each point	Discharged Point	Result
4	20	At the front edge of each HCP opposite the centre point of each unit of the EUT	Pass

Vertical Coupling Plane beside the EUT

Applied Voltage (kV)	No. of Discharge for each point	Discharged Point	Result
4	20	The centre of the vertical edge of the coupling plane	Pass

5.2 EN 61000-6-2 Injected Current (0.15 MHz to 80 MHz)

Tested Port: AC power DC power Functional earth Signal/Control
 Performance criterion: A
 Test Result: Pass

5.2.1 Used Test Equipment

Equip. No.	Equipment	Model	Manufacturer
0900-12	Simulator	CWS500C	EMTEST
33799	CDN	CDN M532S	TESEQ AG
368	Injection Clamp	F-2031-23MM	EMTEST
0010222A	Attenuator	ATT6	EMTEST
Ec3043-4	CDN	CDN T4	EM TEST

5.2.2 Block Diagram of Test Setup

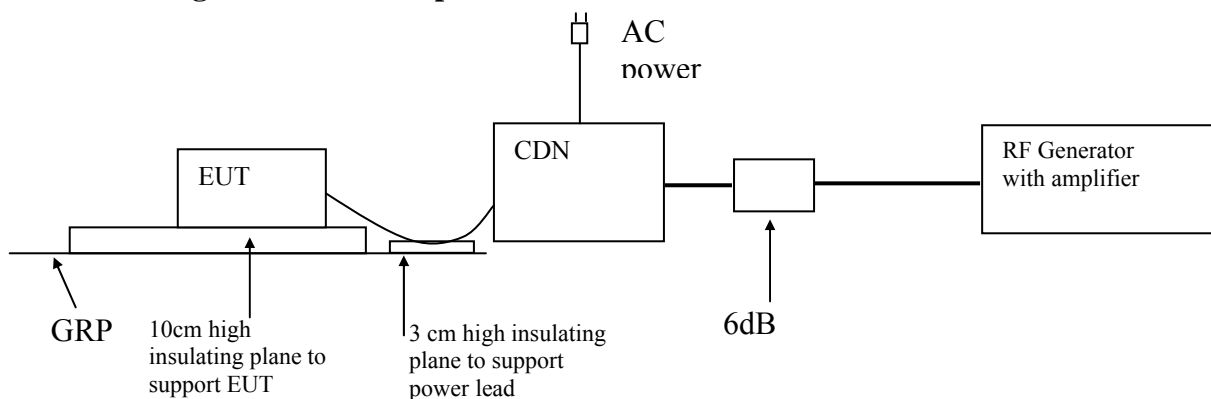

5.2.3 Test Setup and Procedure

The EUT was placed on an insulating support of 0.1m height above a ground reference Plane, arranged and connected to satisfy its functional requirement.

All relevant cables were provided with the appropriate coupling and decoupling devices at a distance between 0.1m and 0.3m from the projected geometry of the EUT on an insulating support of 0.03m height above the ground reference plane.

Test voltage was verified before each testing though power meter combined in the RF generator with AMP.

Dwell time was set to 3s and step was set as 1% to keep sufficient response time for EUT. The frequency from 0.15MHz to 230MHz was checked.

5.2.4 Test Result

Port:	Frequency (MHz)	Level (Pursuant to EN 61000-6-2)	Result
A.C. Power Lines	0.15 to 80	10V (r.m.s.)	Pass
D.C. Power Lines	0.15 to 80	10V (r.m.s.)	Pass
Signal Lines	0.15 to 80	10V (r.m.s.)	N/A

Remark: 1, During actual using, these appliances are connected to solar energy battery modules at DC ports;
 2, No external signal wires.

5.3 EN 61000-6-2 Electrical Fast Transient/Burst

Tested Port: AC power DC power Functional earth Signal/Control

Performance criterion: B

Test Result: Pass

5.3.1 Used Test Equipment

Equip. No.	Equipment	Model	Manufacturer
080981-16	Burst Tester	PEFT4010	HAEFELY
147147	Coupling Clamp	IP-4A	HAEFELY

5.3.2 Block Diagram of Test Setup

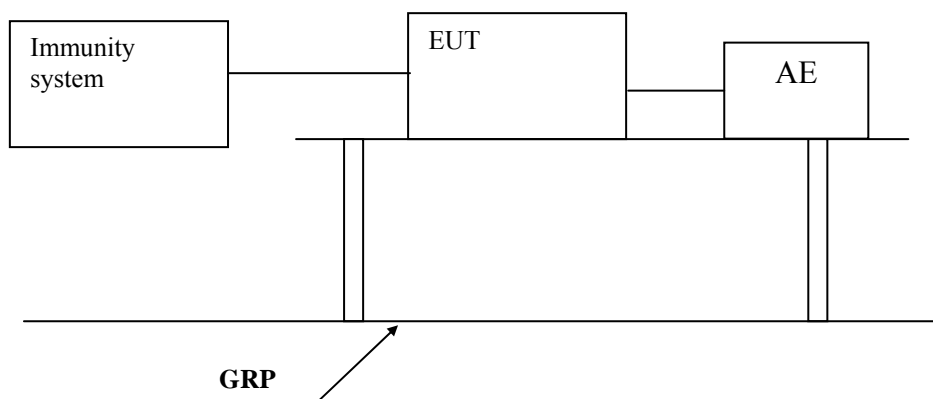

5.3.3 Test Setup and Procedure

The EUT was placed on a 0.1m high wooden table, standing on the ground reference plane 3m by 2m in size, made by steel 1mm thick.

The distance between the EUT and any other of the metallic surface except the GRP is greater than 0.5m.

The mains lead excess than 0.5m is folded to avoid a flat coil and situated at a distance of 0.1m above the ground reference plane to insure the distance between the coupling device and the EUT were 0.5m.

The EUT was arranged and connected to satisfy its functional requirement and supplied by the coupling-decoupling network.

5.3.4 Test Result

Level (Pursuant to EN 61000-6-2)	Polarity	A.C. Power supply line and functional earth terminal	D.C. Power Lines	Signal Line
1.0kV	+	N/A	N/A	N/A
1.0kV	-	N/A	N/A	N/A
2.0kV	+	N/A	Pass	N/A
2.0kV	-	N/A	Pass	N/A
2.0kV	+	Pass	N/A	N/A
2.0kV	-	Pass	N/A	N/A

Remark: 1, During actual using, these appliances are connected to solar energy battery modules at DC ports;
 2, No external signal wires.

5.4 EN 61000-6-2 Surge Immunity

Tested Port: AC power DC power Signal/Control
Performance criterion: B
Test Result: Pass

5.4.1 Used Test Equipment

Equip. No.	Equipment	Model	Manufacturer
174031	Surge Controller	Psurge 8000	HAEFELY
174124	Impulse Module	PIM 100	HAEFELY
172181	Coupling Decoupling Filter	PCD 130	HAEFELY

5.4.2 Block Diagram of Test Setup

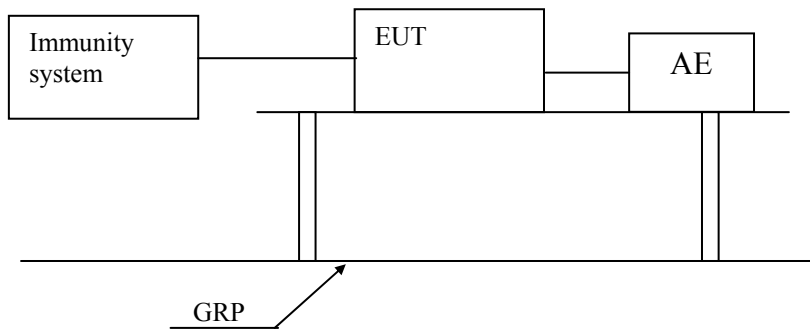

5.4.3 Test Setup and Procedure

The surge is to be applied to the EUT power supply terminals via the capacitive coupling network.

Decoupling networks are required in order to avoid possible adverse effects on equipment not under test that may be powered by the same lines and to provide sufficient decoupling impedance to the surge wave so that the specified wave may be developed on the lines under test.

The EUT was arranged and connected according to its functional requirements. The EUT was placed on a 0.1m high wooden support above the GRP, supplied by the coupling-decoupling network, and arranged and connected to satisfy its functional requirement and the power cord between the EUT and the coupling/decoupling network was less than 2 meters.

Surge is applied to the EUT power supply terminals.

5.4.4 Test Result

Tested Port	Level (Pursuant to EN 61000-6-2)	Result
AC power	Line to line $\pm 1\text{kV}$	Pass
AC power	Line to earth $\pm 2\text{kV}$	Pass
DC power	Line to line $\pm 0.5\text{kV}$	N/A
DC power	Line to earth $\pm 0.5\text{kV}$	N/A
Signal ports	Line to earth $\pm 1.0\text{kV}$	N/A

Remark: 1, During actual using, these appliances are connected to solar energy battery modules at DC ports;
 2, No external signal wires.

5.5 EN 61000-6-2 Voltage Dips and Interruptions

Tested Port: AC power

Test Result: Not Applicable

Remark: The current of AC main port exceeds 16A per phase.

5.6 EN 61000-6-2 Radiated Electromagnetic Field Immunity

Tested Port: Enclosure

Performance criterion: A

Test Result: Pass

5.6.1 Used Test Equipment

Equipment No.	Equipment	Model	Manufacturer
10539	RF Power Meter. Dual Channel	4232A	BOONTON
34236/34238	50ohm Diode Power Sensor	51011EMC	BOONTON
332	Broad-Band Horn Antenna	BBHA 9120 L3F	SCHWARZBE CK
N/A	Power Amplifier	AP32MT215	PRANA
N/A	Power Amplifier	AS0102-55	MILMEGA
N/A	Signal Generator	2023B	AEROFLEX
N/A	Log.-Per. Antenna	VULP 9118E	SCHWARZBE CK

5.6.2 Block Diagram of Test Setup

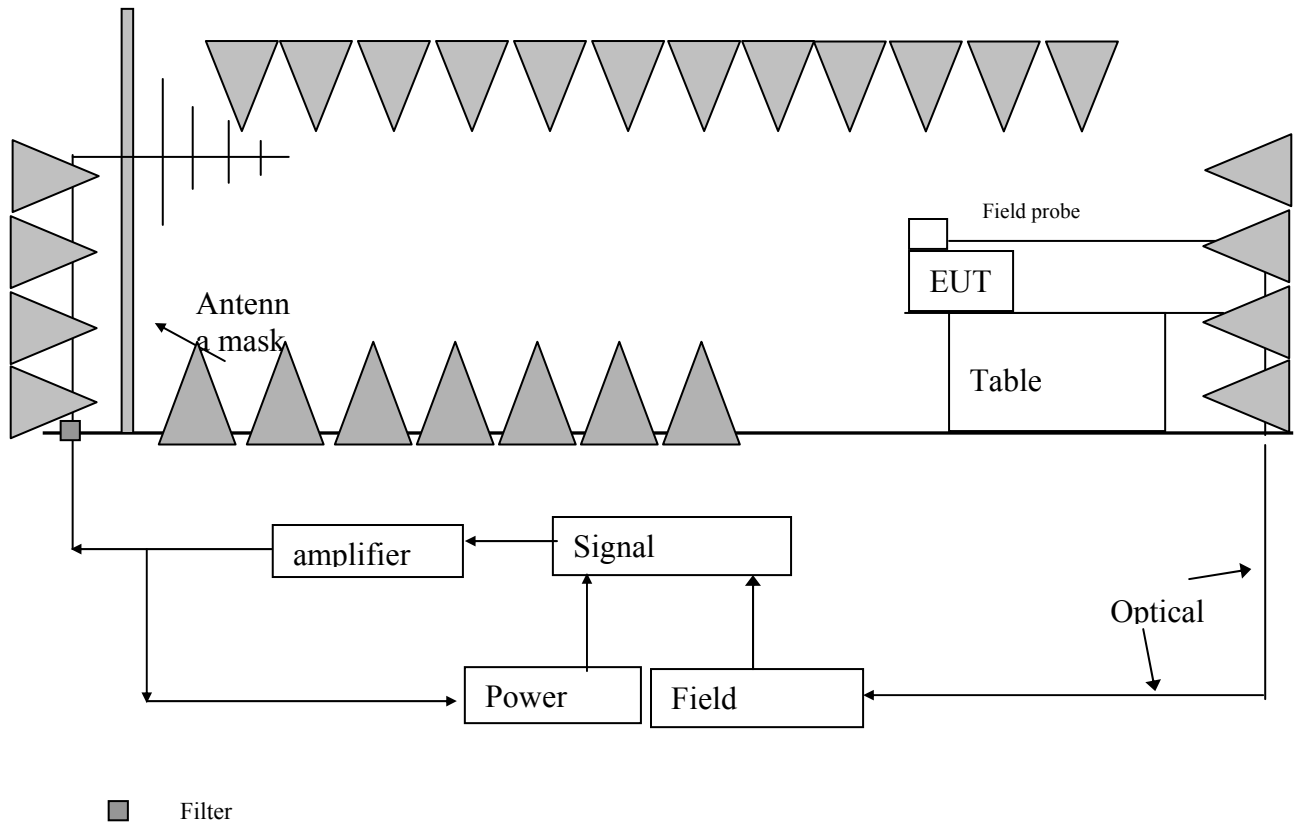

5.6.3 Test Setup and Procedure

The test was conducted in an fully anechoic chamber to maintain a uniform field of sufficient dimensions with respect to the EUT, and also in order to comply with various national and international laws prohibiting interference to radio communications.

The equipment is placed in the test facility on a non-conducting table 0.8m high (for floor standing EUT, is placed on a non-conducting support 0.1m height).

The EUT was placed on the uniform calibrated plane which is 10V/m, 3V/m and 1V/m EM field.

For all ports connected to EUT, manufacturer specified cable type and length was used, for those cables no specification, unshielded cable applied.

Wire is left exposed to the electromagnetic field for a distance of 1m from the EUT.

The EUT was arranged and connected according to its functional requirements

Before testing, the intensity of the established field strength have been checked by placing the field sensor at a calibration grid point, and with the field generating antenna and cables in the same positions as used for the calibration, the forward power needed to give the calibrated field strength was measured.

Spot checks was made at a number of calibration grid points over the frequency range 80 to 1000MHz and 1.4 to 2.7 GHz, both polarizations was checked.

After calibration, the EUT is initially placed with one face coincident with the calibration plane.

The frequency range is swept from 80 to 1000MHz and 1.4 to 2.7 GHz, with the signal 80% amplitude modulated with a 1 kHz sinewave, pausing to adjust the r.f. signal level.

The dwell time at each frequency was 3s so as that the EUT to be exercised and be able to respond.

The step size was 1% of the fundamental with linear interpolation between calibrated points. Test was performed with the generating antenna facing each of the four sides of the EUT.

5.6.4 Test Result

Frequency (MHz)	Exposed Side	Field Strength (V/m)	Result
80 to 1000	Front	10V/m (r.m.s.)	Pass
80 to 1000	Left	10V/m (r.m.s.)	Pass
80 to 1000	Rear	10V/m (r.m.s.)	Pass
80 to 1000	Right	10V/m (r.m.s.)	Pass

Frequency (GHz)	Exposed Side	Field Strength (V/m)	Result
1.4 to 2.0	Front	3V/m (r.m.s.)	Pass
1.4 to 2.0	Left	3V/m (r.m.s.)	Pass
1.4 to 2.0	Rear	3V/m (r.m.s.)	Pass
1.4 to 2.0	Right	3V/m (r.m.s.)	Pass

Frequency (GHz)	Exposed Side	Field Strength (V/m)	Result
2.0 to 2.7	Front	1V/m (r.m.s.)	Pass
2.0 to 2.7	Left	1V/m (r.m.s.)	Pass
2.0 to 2.7	Rear	1V/m (r.m.s.)	Pass
2.0 to 2.7	Right	1V/m (r.m.s.)	Pass

5.7 EN 61000-6-2 Power Frequency Magnetic Field Immunity

Tested Port: Enclosure
Performance criterion: A
Test Result: Pass

5.7.1 Used Test Equipment

Equipment No.	Equipment	Model	Manufacturer
250040.1	Magnetic Field Tester	MAG100	HAEFELY

5.7.2 Block Diagram of Test Setup

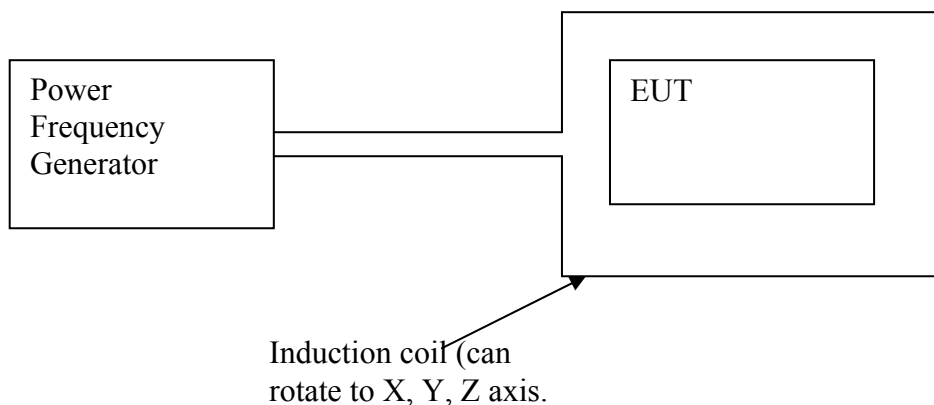

5.7.3 Test Setup and Procedure

Put EUT into center of induction coil(with suitable dimensions) in the testing.

For tabletop equipment:

The EUT was placed on a big enough wooden desk with height of 0.8m and operating as intended.

The equipment shall be subjected to the test magnetic field by using the induction coil of standards(1m*1m).

The induction coil shall be rotated by 90° in order to expose the EUT to the test field with different orientations.

For Floor-standing equipment:

The EUT was placed on big enough wooden desk with height of 0.1m and operating as intended.

The equipment shall be subjected to the test magnetic field by using induction coils of suitable dimensions ; the test shall be repeated by moving and shifting the induction coils, in order to test the whole volume of the EUT for each orthogonal direction. The test shall be repeated with the coil shifted to different position along the side of the EUT, in steps corresponding to 50% of the shortest side of the coil.

The induction coil shall then be rotated by 90° in order to expose the EUT to the test field with different orientations and the same procedure followed.

5.7.4 Test Result

Mains frequency: 50Hz 60Hz

Orientations of induction coil	Magnetic Field Strength (A/m)	Result
X	30A/m	Pass
Y	30A/m	Pass
Z	30A/m	Pass

Remark: For the dimensions of this product are so large, in practical testing, the proximity method was used.

6 Appendix I - Photos of test setup

Continuous/Discontinuous conducted disturbance voltage



Radiated emission (30 MHz–1000 MHz)

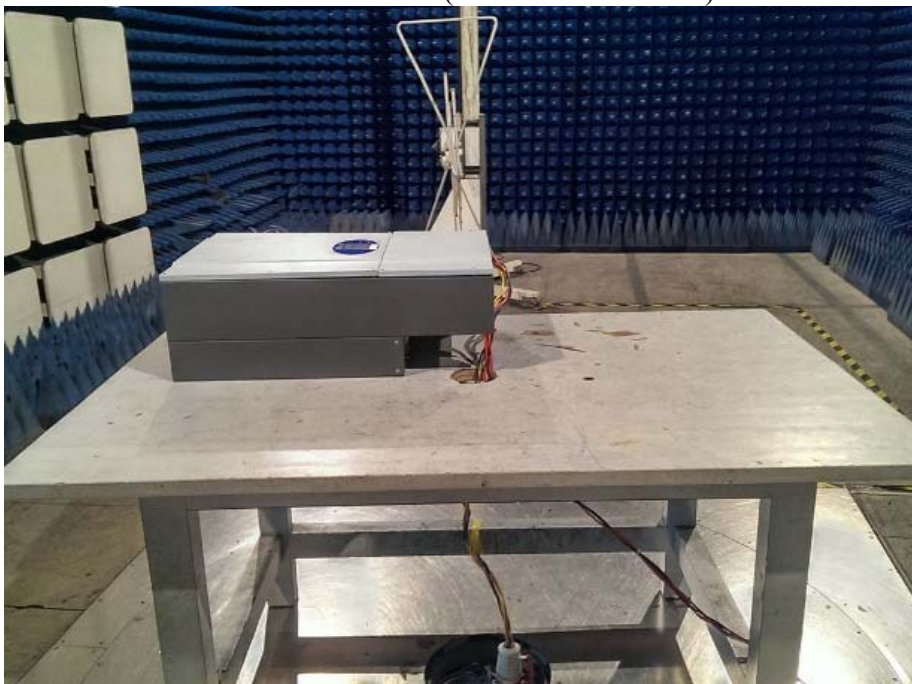

ESD immunity

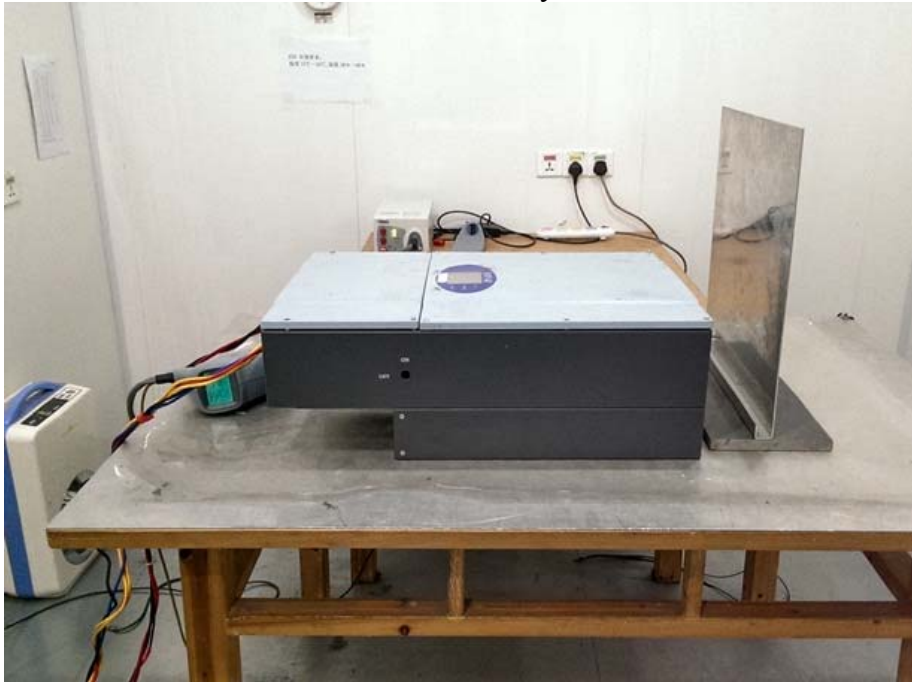

Radiated EM field immunity (80-1000MHz)

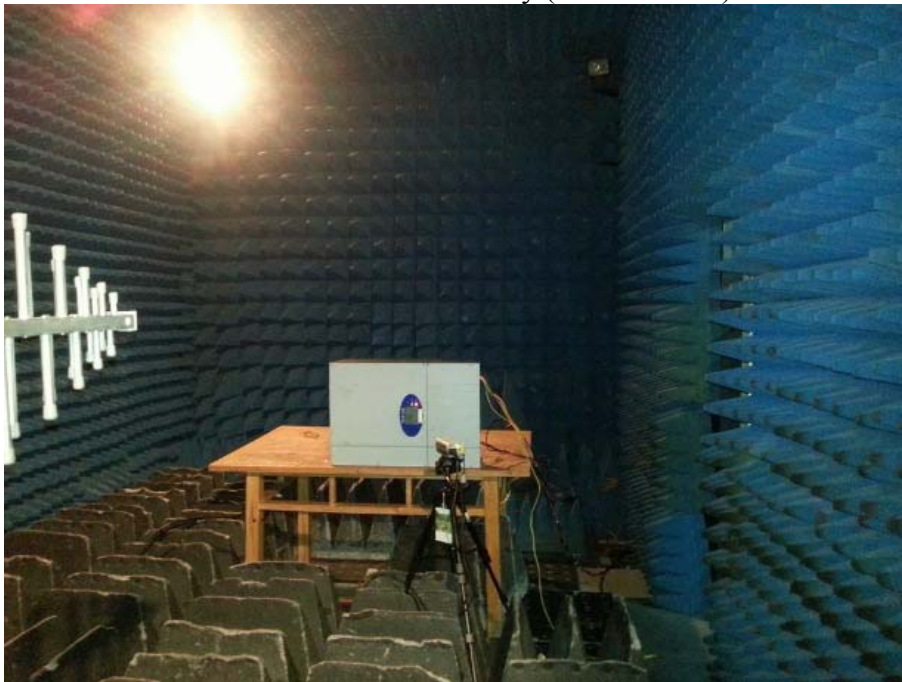

Radiated EM field immunity (1400-2700MHz)

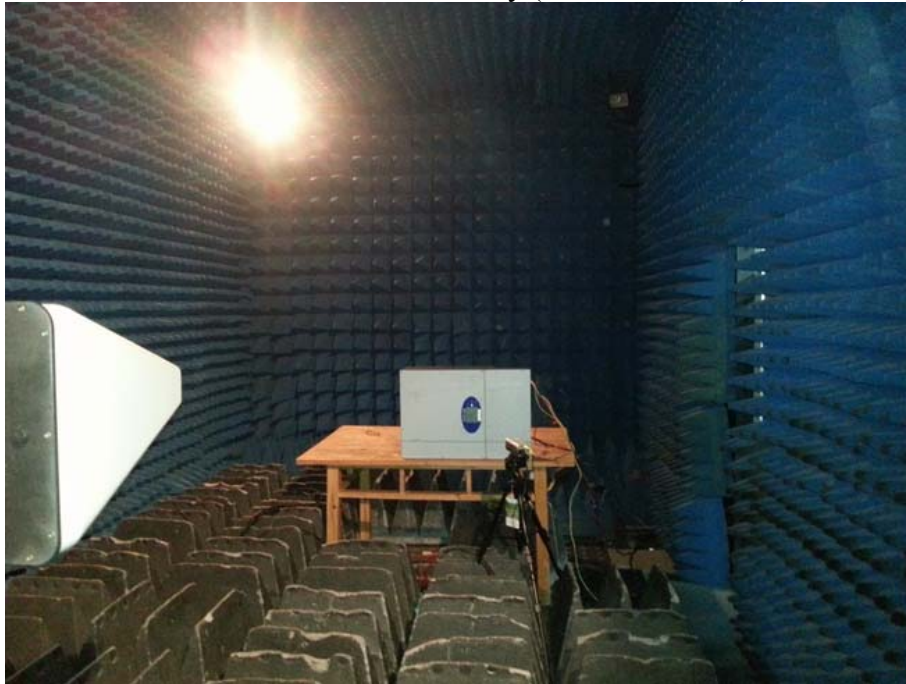

SURGE immunity



EFT immunity

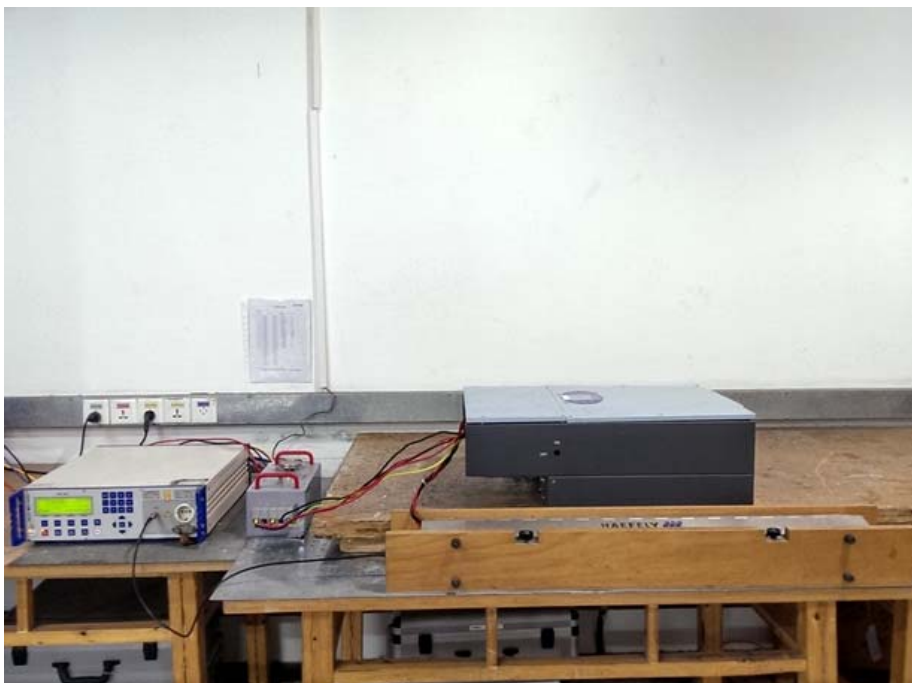

Inject current immunity



Power frequency magnetic field immunity

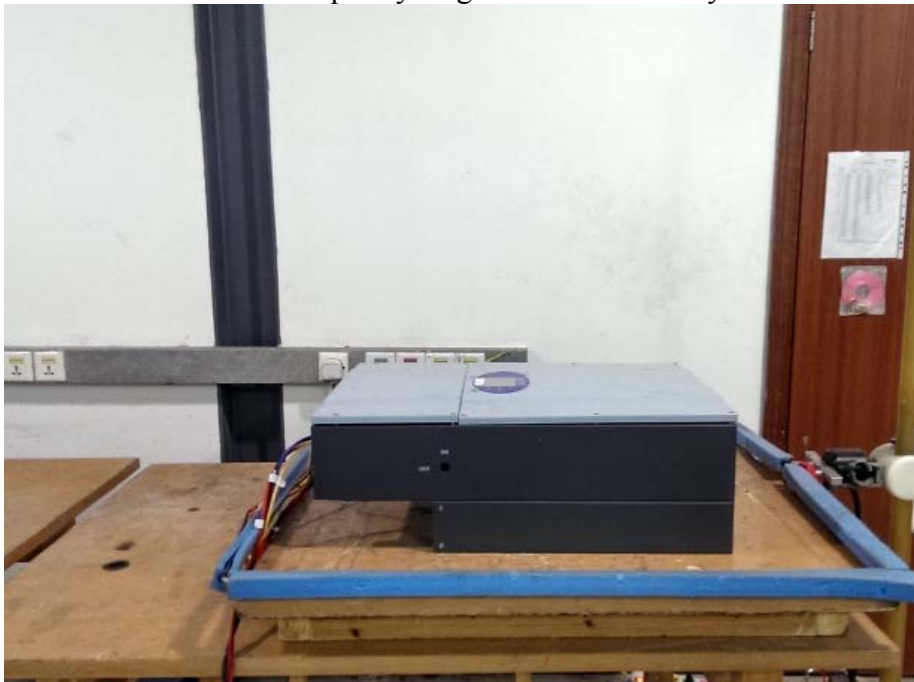

7 Appendix II- Photos of EUT

Overall view of the unit



Bottom view of the unit

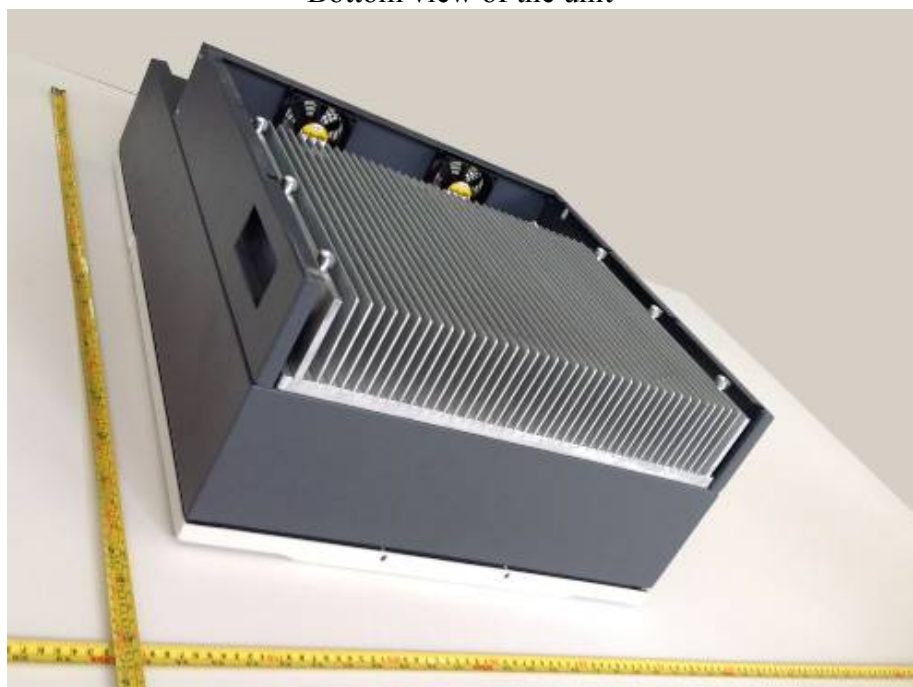

Terminals view of the unit (for models “-S2” to “-S6”)
PV connector (Sofar 20000TL-Sx and Sofar 17000TL-Sx has 3×2 pairs)
(Sofar 15000TL-Sx and Sofar 10000TL-Sx has 2×2 pairs)



Terminals view of the unit (for models “-S0” to “-S1”)
DC Cable Gland



Internal view of the unit



Internal view of the unit
Input board, Control board, Output board

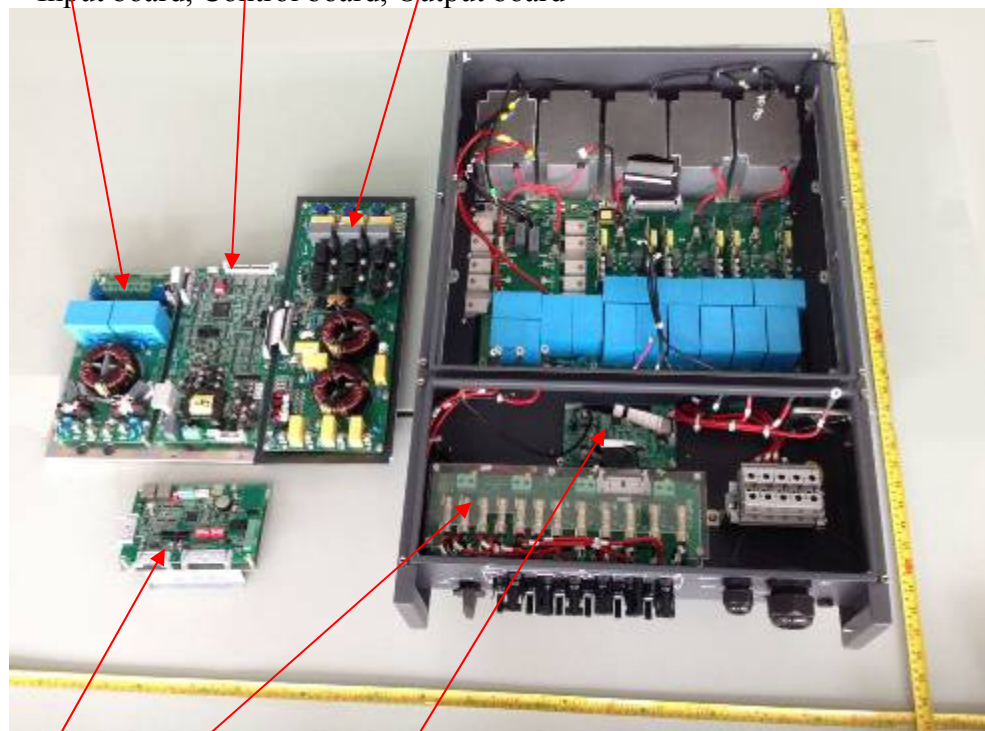

COM board, Fuse board, String detection board

DC surge arrester AC surge arrester

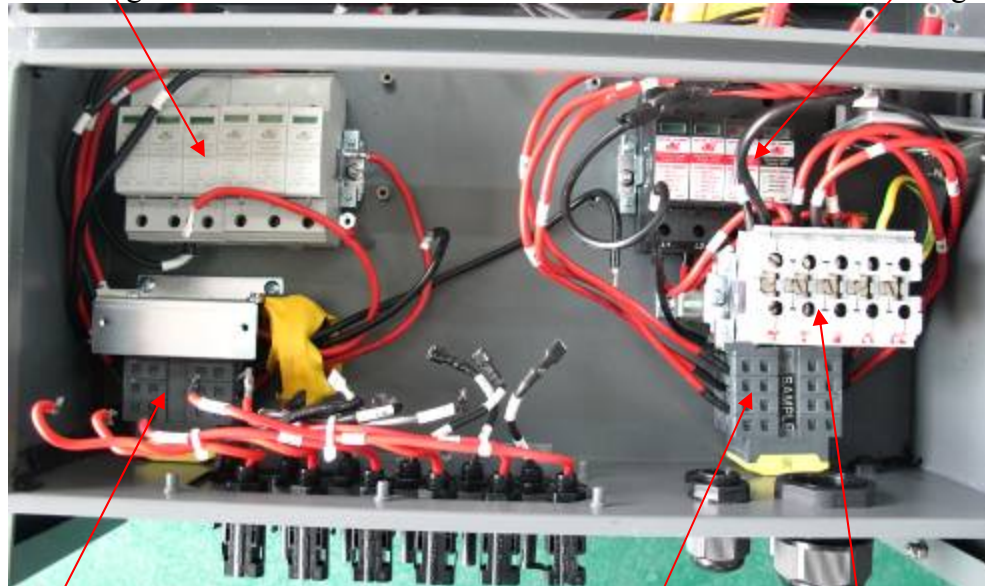

DC switch

AC switch, AC output connector

Internal view of the unit

DC inside connector

AC output connector



Earthing terminal of the unit



Support board for the PCBs

Insulation sheet

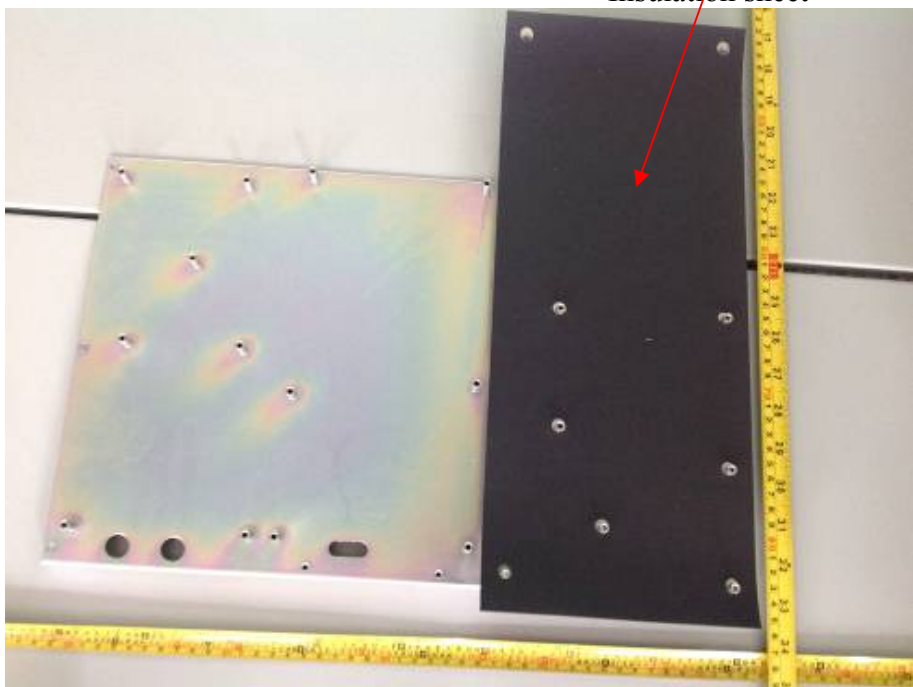

Cavity view of the enclosure



Front view of the input board

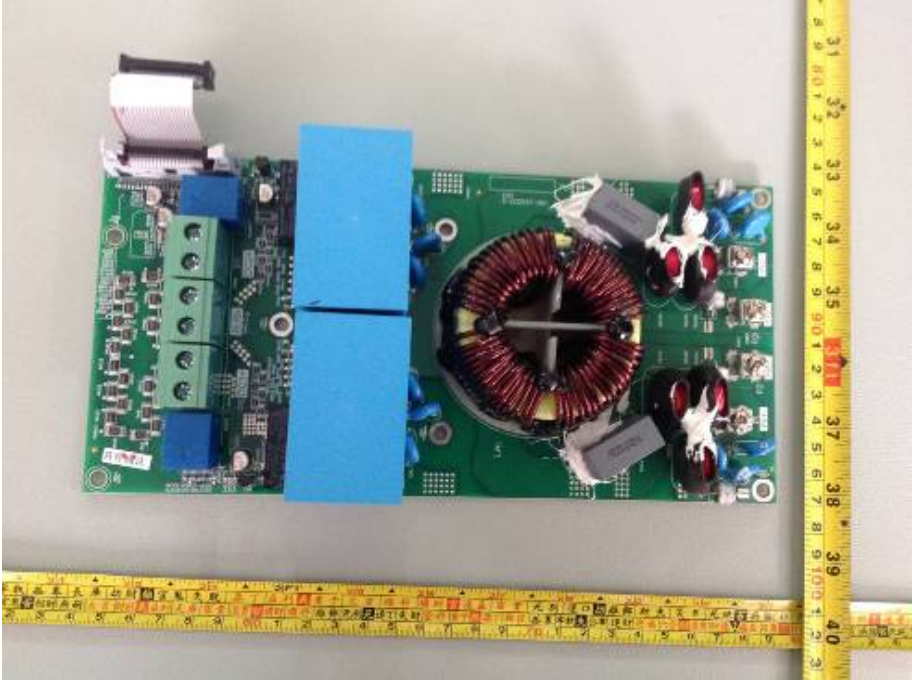

Bottom view of the input board

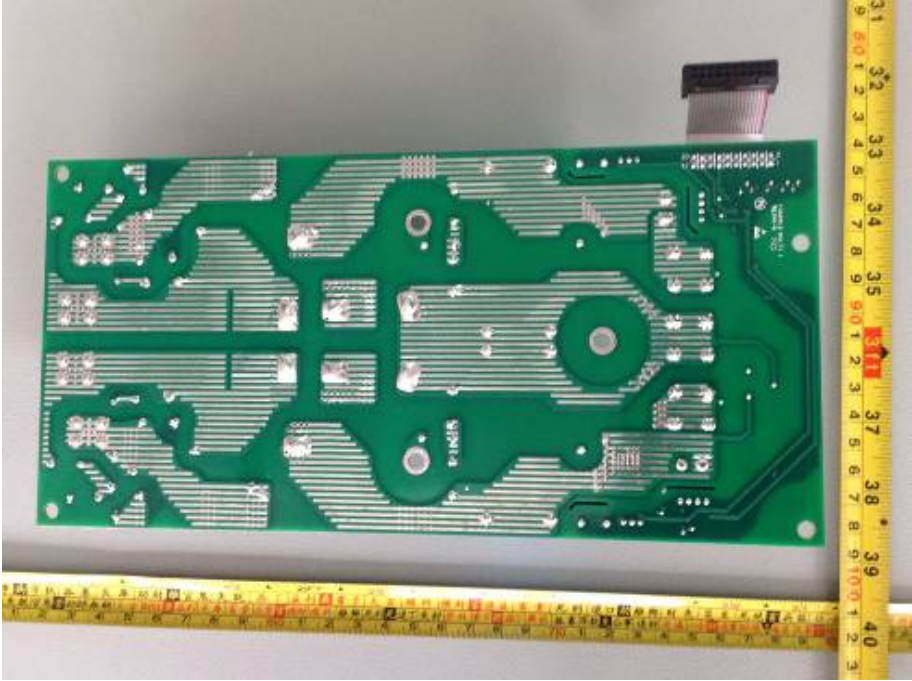

Front view of the control board



Bottom view of the control board

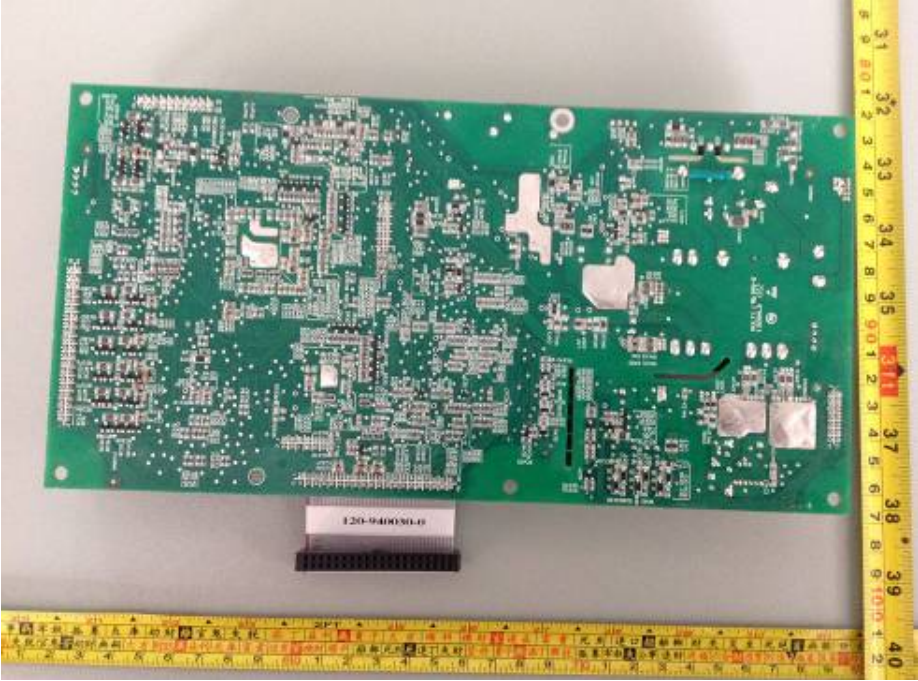

Front view of the output board

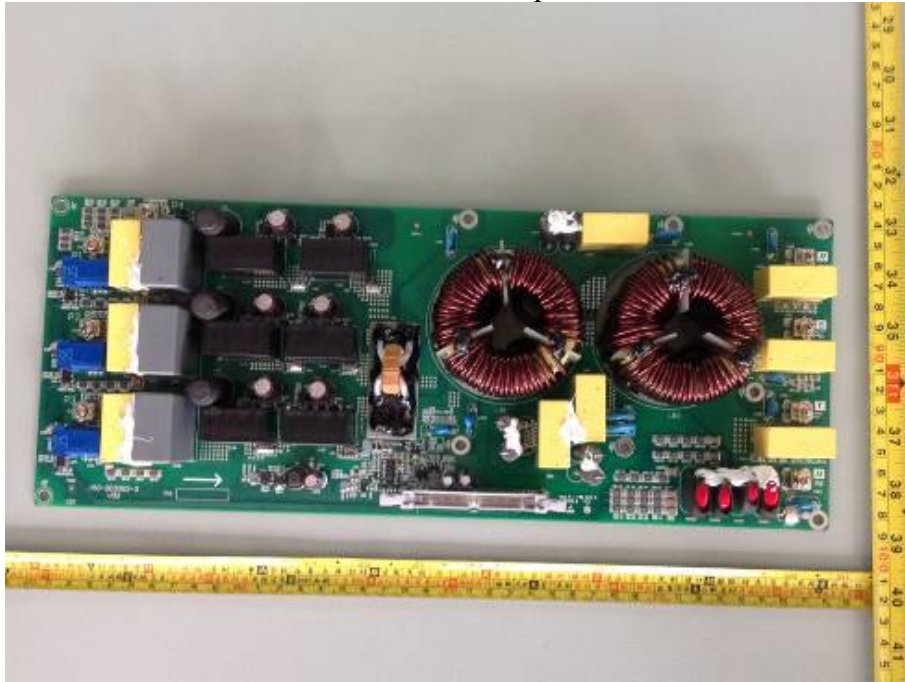

Bottom view of the output board

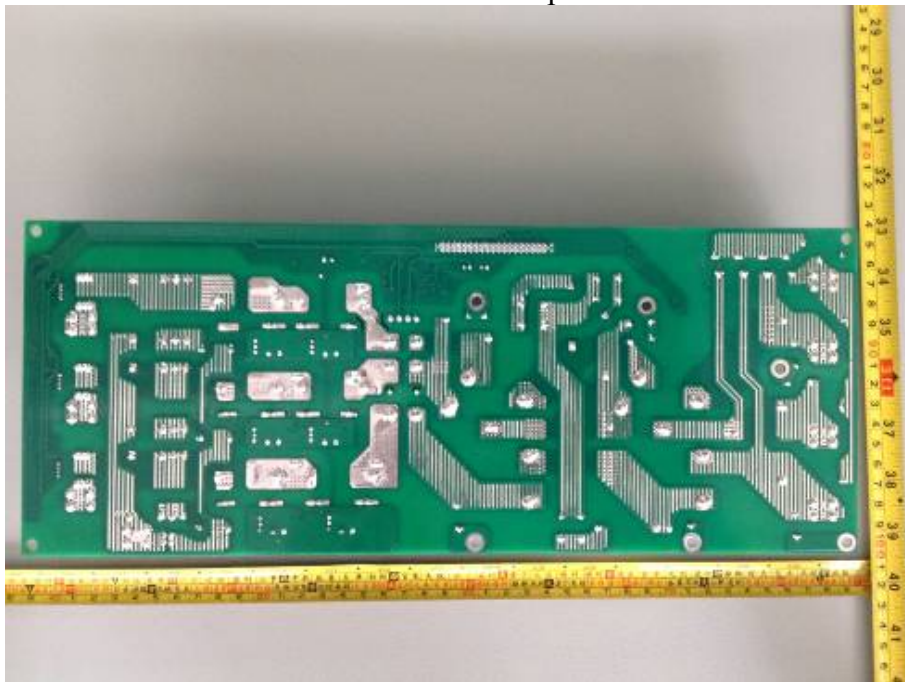

Front view of the COM board

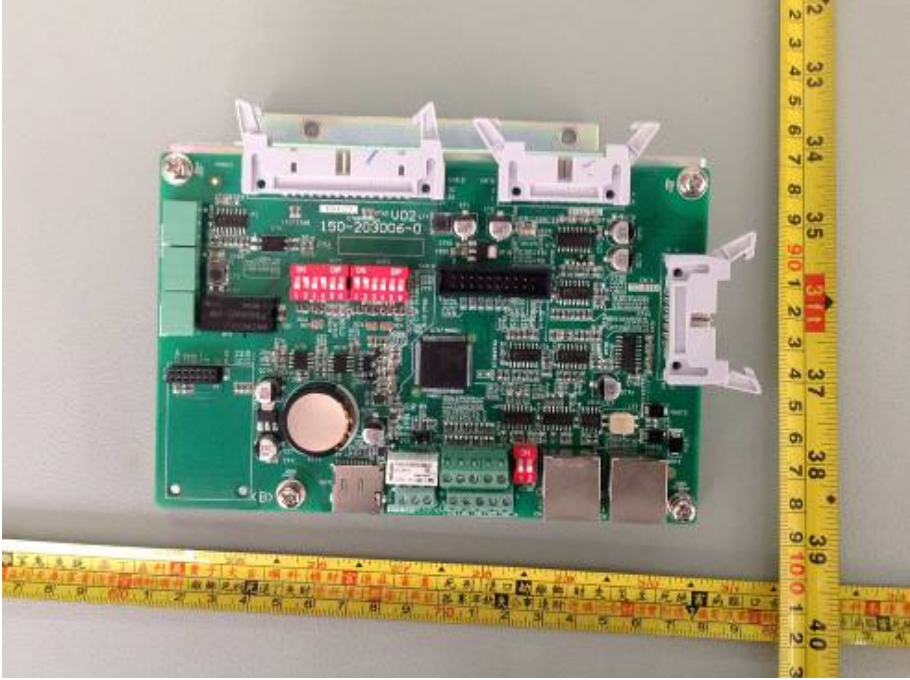

Bottom view of the COM board



Front view of the fuse board



Bottom view of the fuse board

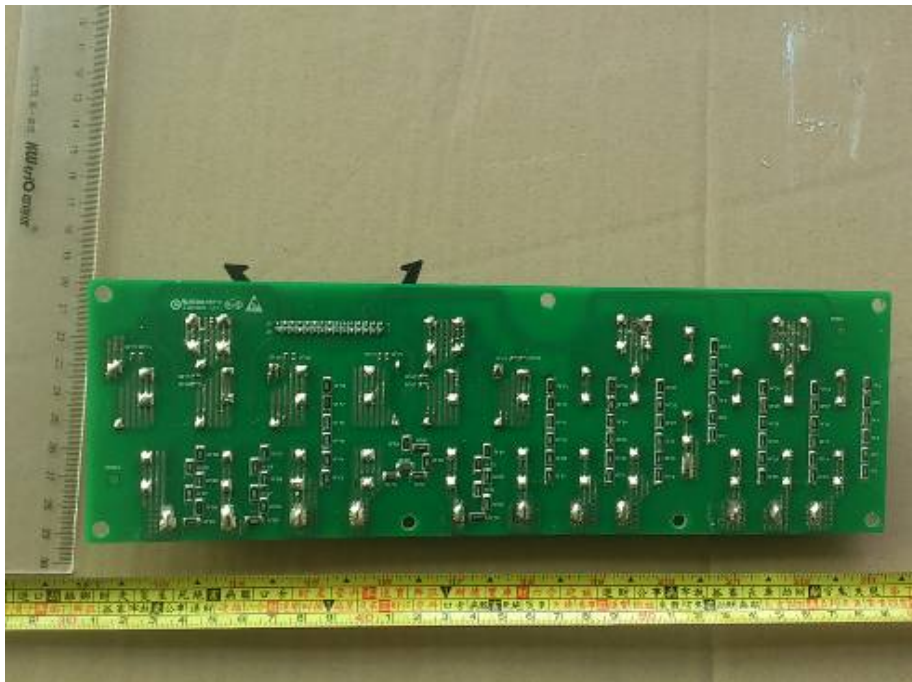

Front view of the string detection board

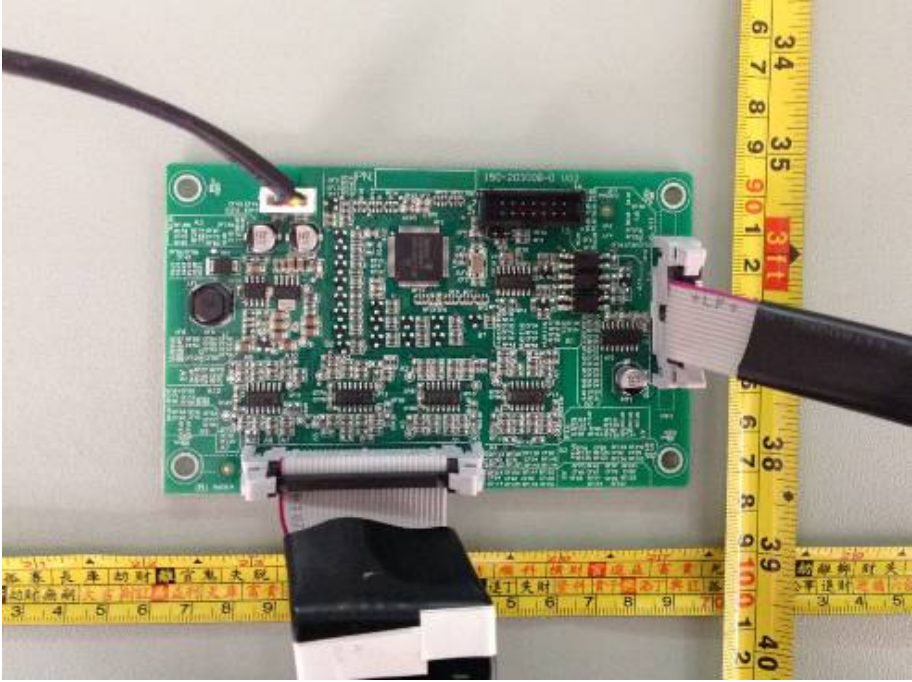

Bottom view of the string detection board

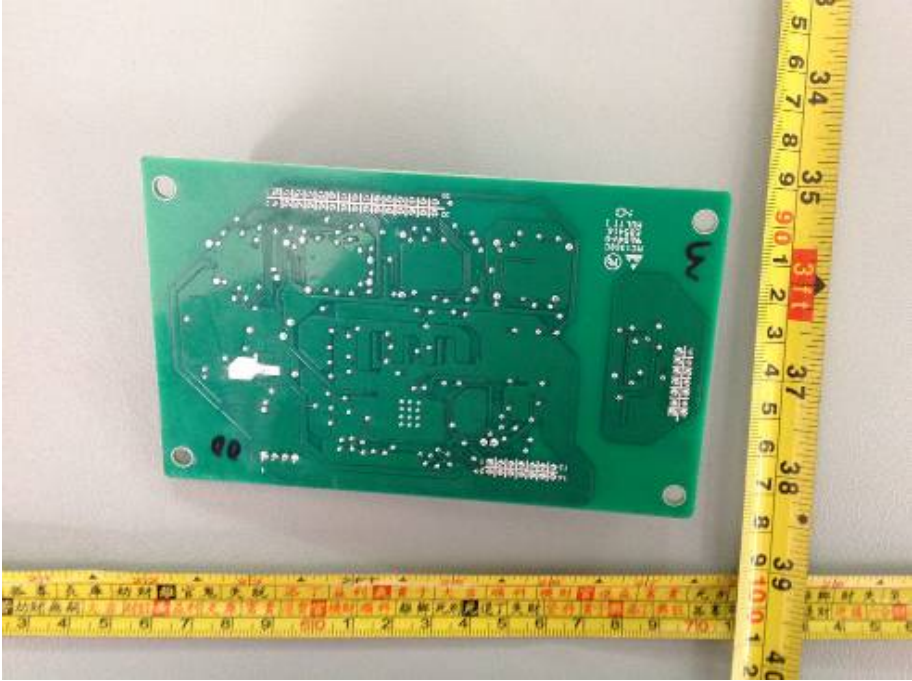

Front view of the power board

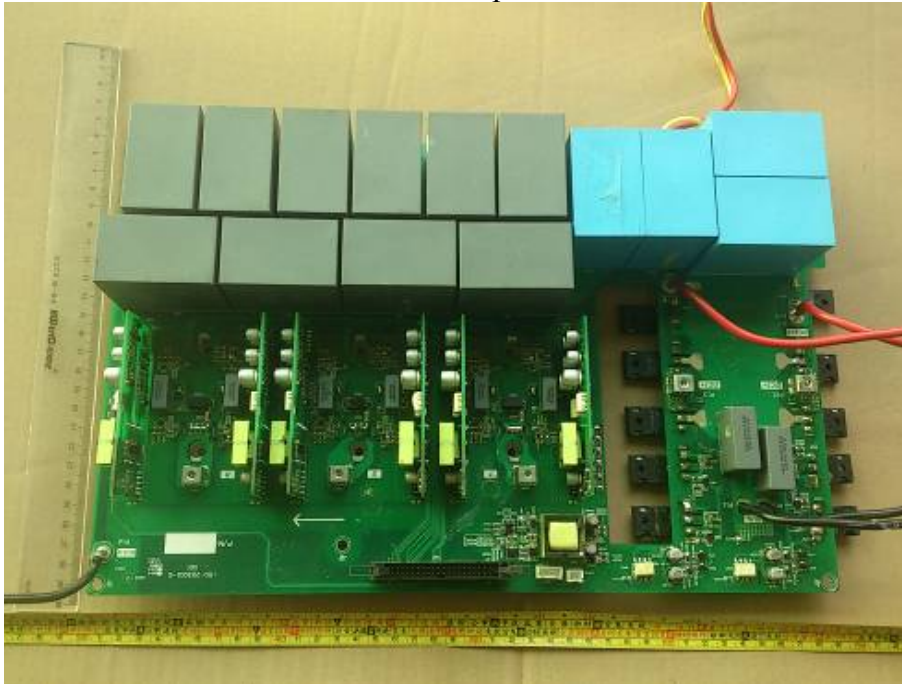

Bottom view of the power board

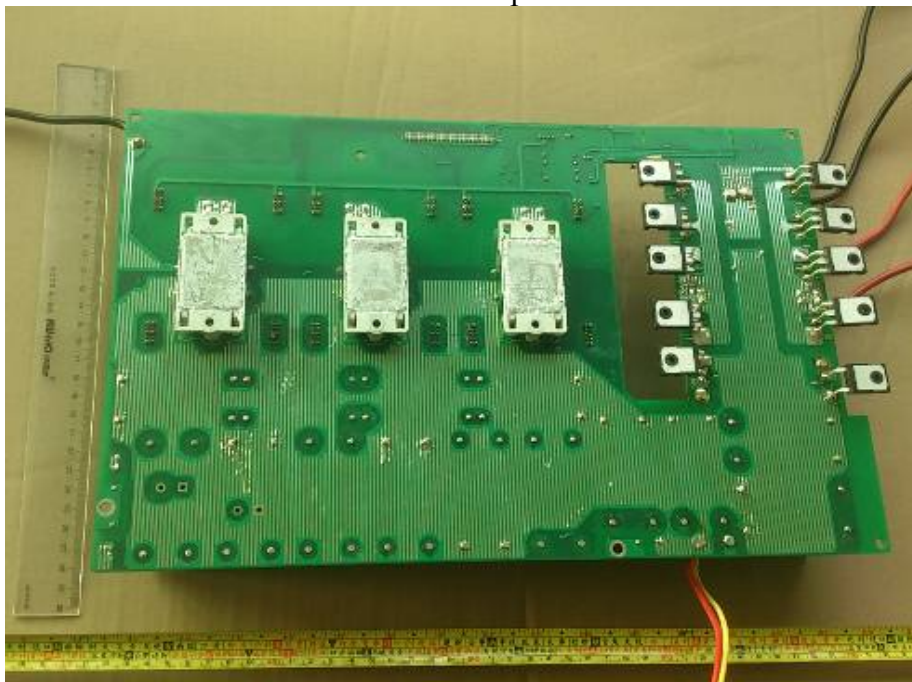

Front view of the driver board

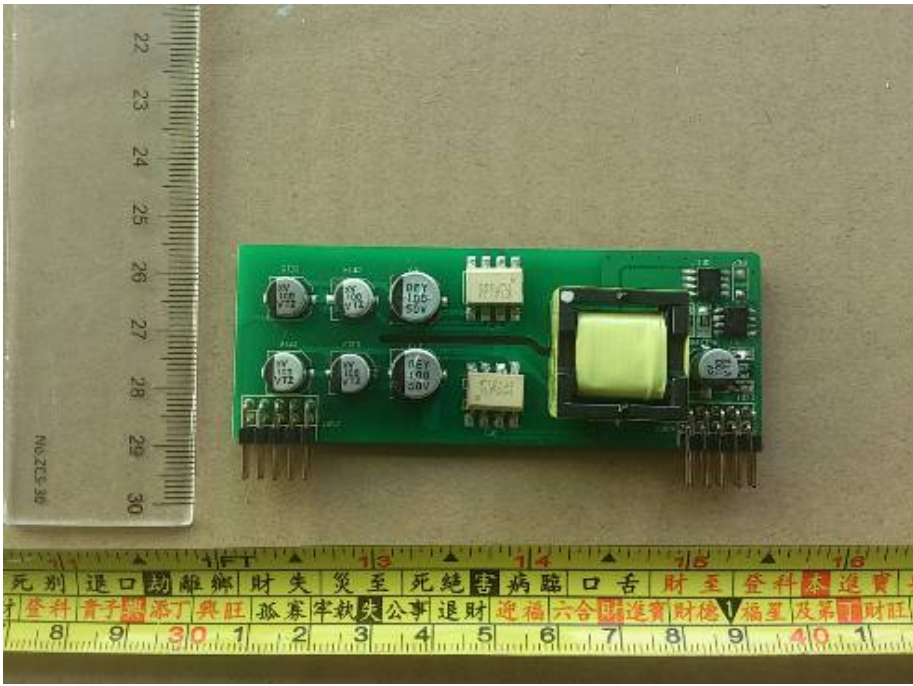

Bottom view of the driver board

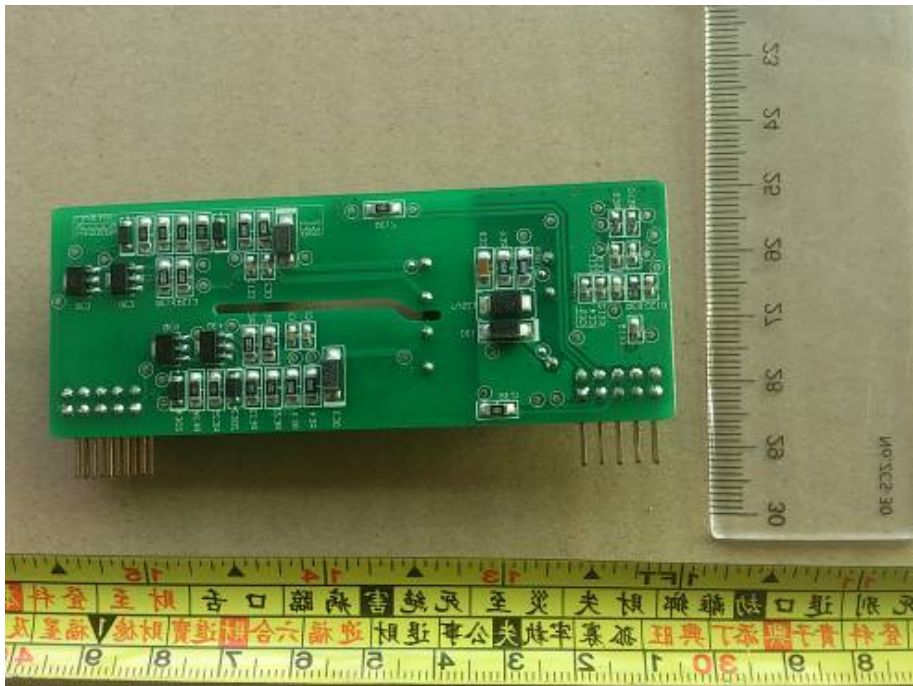

Front view of the display board



Bottom view of the display board

